

Air Circuit Breakers

Configuration Manual · 2012



SENTRON

Answers for infrastructure.

SIEMENS

3WL Air Circuit Breakers



2

Introduction

3WL air circuit breakers

3WL air circuit breakers/non-automatic air circuit breakers up to 6300 A (AC)

General data

- 6 - Design
- 12 - Function
- 19 - Configuration
- 24 - Technical specifications

Project planning aids

- 34 - Characteristic curves
- 36 - Dimensional drawings
- 49 - Circuit diagrams
- 51 - More information

3WL non-automatic air circuit breakers up to 4000 A (DC)

General data

- 52 - Technical specifications

Project planning aids

- 53 - Characteristic curves
- 53 - Dimensional drawings
- 57 - Circuit diagrams
- 58 - More information

© Siemens AG 2011
All dimensions in mm.

3WL Air Circuit Breakers

Introduction

Overview



Size I



Size II



Size III

3WL air circuit breakers

3WL air circuit breakers/non-automatic air circuit breakers for AC, up to 6300 A, IEC

3WL non-automatic air circuit breakers up to 4000 A (DC)

Sizes		I, II, III			II
Rated current I_n	A	630, 800, 1000, 1250, 1600, 2000, 2500, 3200, 4000, 5000, 6300			1000, 2000, 4000
Number of poles		3-pole, 4-pole			3-pole, 4-pole
Rated operational voltage U_e	V AC V DC	... 690/1000/1150 --			-- ... 1000
Rated ultimate short-circuit breaking capacity at 500 V AC	kA	Size I 55/66/85	Size II 66/80/100	Size III 100/150 (3-pole), 130 (4-pole)	30/25/20 (at 300/600/1000 V DC)
Endurance	Operating cycles	Up to 20000	15000	10000	15000
Mounting position					
Degree of protection	With cover Without cover (with door sealing frame)	IP55 IP41			IP55 IP41
Dimensions 3-/4-pole	W mm H mm D mm	320/410 434 291	460/590 434 291	704/914 434 291	460/590 434 291
	Fixed mounting	H mm D mm	434 291	434 291	434 291
	Withdrawable	H mm D mm	465,5 471	465,5 471	465,5 471



Type	ETU15B ¹⁾	ETU25B	ETU27B	ETU45B	ETU76B
Electronic releases for 3WL circuit breakers					
Overload protection	✓	✓	✓	✓	✓
Short-time delayed short-circuit protection	--	✓	✓	✓	✓
Instantaneous short-circuit protection	✓	✓	✓	✓	✓
Neutral conductor protection	--	--	✓	✓	✓
Ground-fault protection	--	--	✓	□	□
Zone Selective Interlocking	--	--	--	□	□
LCD, 4-line	--	--	--	□	--
LCD, graphic	--	--	--	--	✓
Communication	--	--	--	□	□
Measurement function <i>Plus</i>	--	--	--	□	□
Selectable parameter sets	--	--	--	--	✓
Parameters freely programmable	--	--	--	--	✓
CubicleBUS	--	--	--	✓	✓

- ✓ Standard
- Not available
- Optional

¹⁾ ETU15B cannot be used with 3WL circuit breakers, size III.

3WL air circuit breakers/non-automatic air circuit breakers according to UL 489 up to 5000 A, see [Catalog LV 16](#).

Switching capacity

Sizes		I			II			III			
Type		3WL11			3WL12			3WL13			
Switching capacity class		N	S	H	N	S	H	H	C 3-pole	C 4-pole	
Short-circuit breaking capacity											
Rated operational voltage U_e up to 415 V AC											
I_{cu}	kA	55	66	85	66	80	100	100	150	130	
I_{cs}	kA	55	66	85	66	80	100	100	150	130	
I_{cm}	kA	121	145	187	145	176	220	220	330	286	
Rated operational voltage U_e up to 500 V AC											
I_{cu}	kA	55	66	85	66	80	100	100	150	130	
I_{cs}	kA	55	66	85	66	80	100	100	150	130	
I_{cm}	kA	121	145	187	145	176	220	220	330	286	
Rated operational voltage U_e up to 690 V AC											
I_{cu}	kA	42	50	66	50	75	85	85	150	130	
I_{cs}	kA	42	50	66	50	75	85	85	150	130	
I_{cm}	kA	88	105	145	105	165	187	187	330	286	
Rated operational voltage U_e up to 1000 V/1150 V AC											
I_{cu}	kA	--	--	50 ⁹⁾	--	--	50	50	70 ⁴⁾	70 ⁴⁾	
I_{cs}	kA	--	--	50 ⁹⁾	--	--	50	50	70 ⁴⁾	70 ⁴⁾	
I_{cm}	kA	--	--	105 ⁹⁾	--	--	105	105	154 ⁴⁾	154 ⁴⁾	
Rated short-time withstand current I_{cw} of the circuit breakers³⁾											
0.5 s	kA	55	66	75	66	80	100	100	100	100	
1 s	kA	42	50	66	55	66	80	100	100	100	
2 s	kA	29,5	35	46	39	46	65 ^{1)/70²⁾}	80	80	80	
3 s	kA	24	29	37	32	44	50 ^{1)/65²⁾}	65	65	65	
Short-circuit breaking capacity I_{cc} of the non-automatic air circuit breakers											
Up to 500 V AC	kA	55	66	75	66	80	100	100	100	100	
Up to 690 V AC	kA	42	50	66	50	75	85	85	100	100	
Up to 1000 V /1150 V AC	kA	--	--	50 ⁹⁾	--	--	50 ⁴⁾	50 ⁴⁾	70 ⁴⁾	70 ⁴⁾	

Sizes		II	
Type		3WL12	
Switching capacity class		DC	
Short-circuit breaking capacity			
Up to 220 V DC	I_{cc}	kA	35
Up to 300 V DC	I_{cc}	kA	30
Up to 600 V DC	I_{cc}	kA	25
Up to 1000 V DC	I_{cc}	kA	20
Rated short-time withstand current I_{cw}			
0.5 s	kA	--	
1 s	kA	35 ^{5)/30^{6)/25^{7)/20⁸⁾}}}	
2 s	kA	--	
3 s	kA	--	

- (N)** Circuit breaker with ECO switching capacity N
- (S)** Circuit breaker with standard switching capacity S
- (H)** Circuit breaker with high switching capacity H
- (C)** Circuit breakers with very high switching capacity C
- (DC)** Non-automatic air circuit breakers with DC switching capacity

These switching capacities are indicated in the corresponding tables by the symbols shown on orange backgrounds.

- 1) Size II with $I_{n \max} \leq 2500$ A.
- 2) Size II with $I_{n \max} = 3200$ A and $I_{n \max} = 4000$ A.
- 3) At a rated voltage of ≥ 690 V the I_{cw} value of the circuit breaker cannot be greater than the I_{cu} or I_{cs} value at 690 V.
- 4) Rated operational voltage $U_e = 1150$ V.
- 5) At $U_e = 220$ V DC.

Abbreviations (functions)

L	= Long Time Delay	= Overload protection
S	= Short Time Delay	= Short-circuit protection (short-time delayed)
I	= Instantaneous	= Short-circuit protection (instantaneous)
N	= Neutral Protection	Neutral conductor protection
G	= Ground Fault	Ground-fault protection

L, S, I, N, G: Designation according to IEC 60947-2, Appendix K.

6) At $U_e = 300$ V DC.

7) At $U_e = 600$ V DC.

8) At $U_e = 1000$ V DC.

9) Values also apply to version 690 V + 20 % with Z option "A16".

3WL Air Circuit Breakers

Introduction

3WL air circuit breakers:
Superior individual products integrated into uniform power distribution systems - up to and including industry-specific industrial and infrastructure solutions

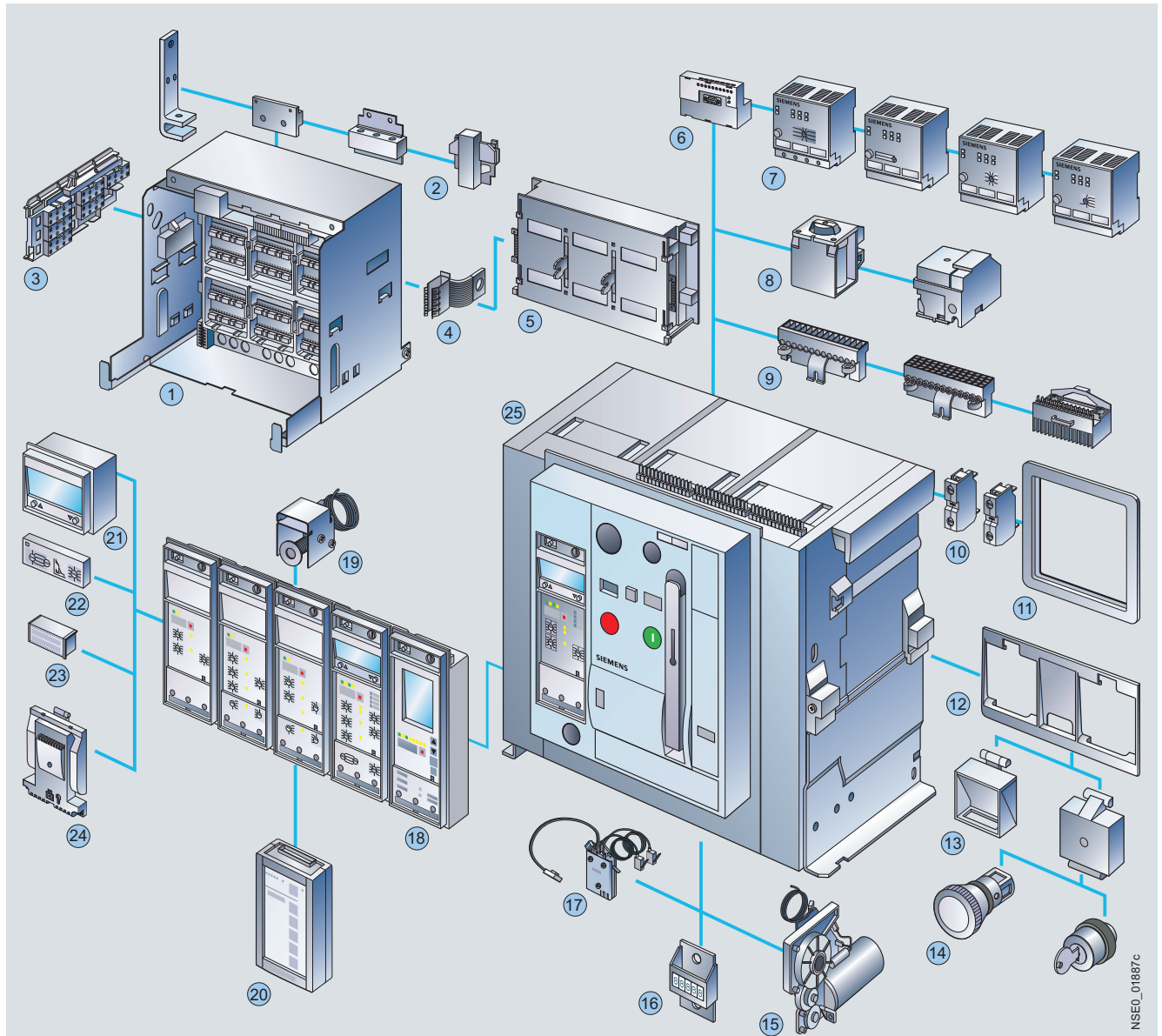

- | | |
|--|--|
| ① Guide frame | ⑬ Transparent panel, function insert |
| ② Main circuit connection, front, flange, horizontal, vertical | ⑭ EMERGENCY-STOP pushbutton, key operated |
| ③ Position signaling switch | ⑮ Motorized operating mechanism |
| ④ Grounding connection, leading | |
| ⑤ Shutter | |
| ⑥ COM15 PROFIBUS modules or COM16 MODBUS modules | |
| ⑦ External Cubicle BUS modules | |
| ⑧ Closing solenoid, auxiliary release | ⑯ Operating cycles counter |
| ⑨ Auxiliary conductor plug-in system | ⑰ Breaker Status Sensor (BSS) |
| ⑩ Auxiliary switch block | ⑱ Protective devices with device holder, electronic releases (ETU) |
| ⑪ Door sealing frame | ⑲ Remote reset solenoid |
| ⑫ Interlocking set for mechanical ON/OFF | ⑳ Breaker Data Adapter (BDA Plus) |
| ⑬ Transparent panel, function insert | ㉑ Four-line display |
| ⑭ EMERGENCY-STOP pushbutton, key operated | ㉒ Ground-fault protection module |
| ⑮ Motorized operating mechanism | ㉓ Rated current module |
| | ㉔ Measuring function module |
| | ㉕ Circuit breaker |

NSE0_01887c

Communication-capable circuit breakers (with ETU45B or ETU76B electronic release)

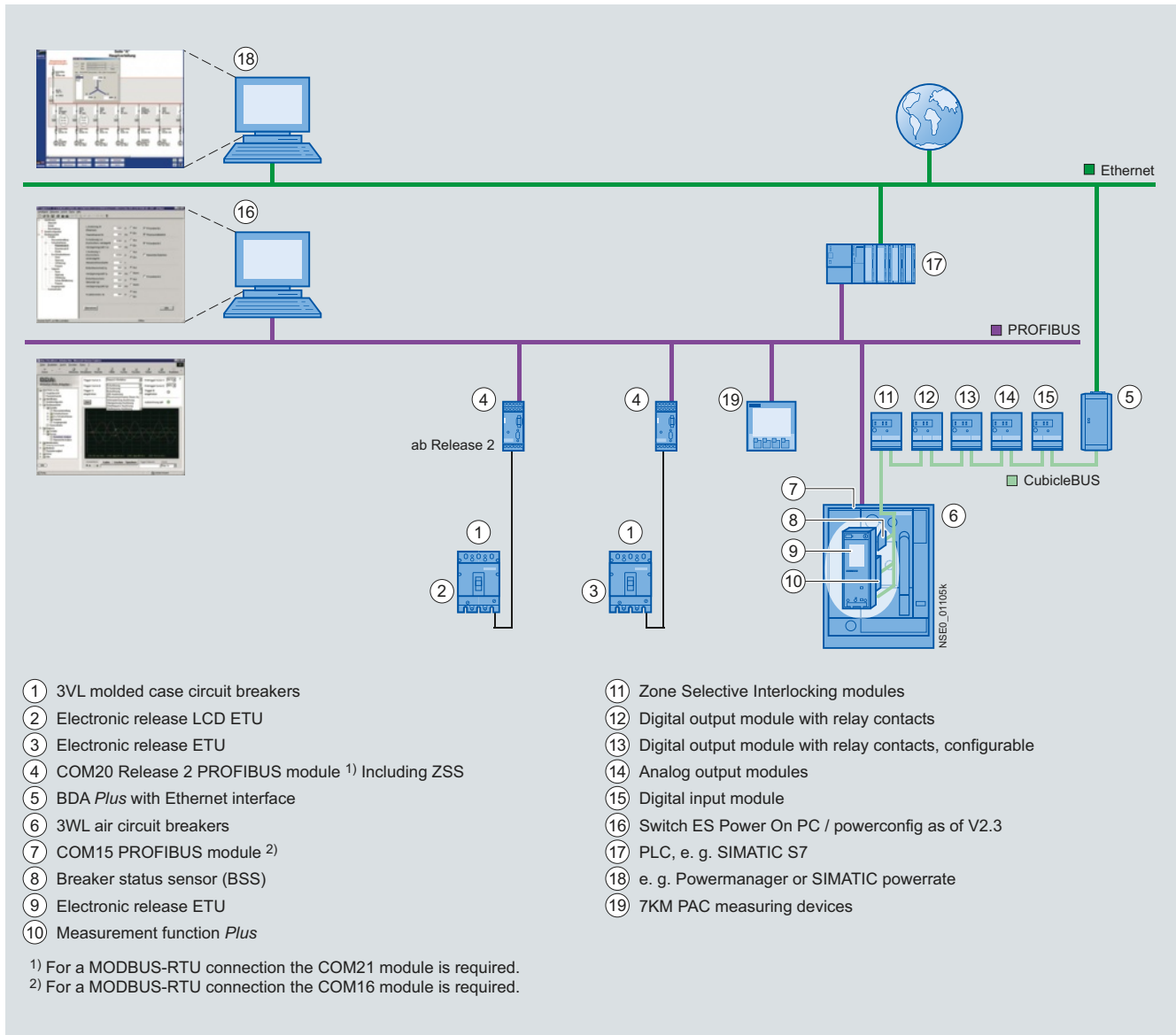

① 3WL molded case circuit breakers

② Electronic release LCD ETU

③ Electronic release ETU

④ COM20 Release 2 PROFIBUS module ¹⁾ Including ZSS

⑤ BDA Plus with Ethernet interface

⑥ 3WL air circuit breakers

⑦ COM15 PROFIBUS module ²⁾

⑧ Breaker status sensor (BSS)

⑨ Electronic release ETU

⑩ Measurement function Plus

⑪ Zone Selective Interlocking modules

⑫ Digital output module with relay contacts

⑬ Digital output module with relay contacts, configurable

⑭ Analog output modules

⑮ Digital input module

⑯ Switch ES Power On PC / powerconfig as of V2.3

⑰ PLC, e. g. SIMATIC S7

⑱ e. g. Powermanager or SIMATIC powerrate

⑲ 7KM PAC measuring devices

Features

- Coordinated communication concept using the PROFIBUS DP or MODBUS, ranging from 16 A to 6300 A with 3WL compact circuit breakers and 3WL air circuit breakers
- The high level of modularity of circuit breakers and accessories allows easy retrofitting of all communication components
- Significant additional benefits for the switchboard due to the possibility of linking up external input and output modules to the circuit breaker-internal **CubicleBUS** of the 3WL air circuit breaker
- Innovative software products for parameterization, operation, monitoring, and diagnostics of circuit breakers, both locally or via PROFIBUS DP, MODBUS or Ethernet/Intranet/Internet
- Complete integration of the circuit breakers into the Totally Integrated Power and Totally Integrated Automation solutions

Communication:

- For air circuit breakers with optional communication function (ETU45B or ETU76B electronic release) [see Catalog LV 10.1](#).
- For accessories [see Catalog LV 10.1](#).
- For more information [see also Catalog LV 10.1, chapter "Measuring Devices and energy management" and "Software"](#).

3WL Air Circuit Breakers

3WL Air Circuit Breakers/Non-Automatic Air Circuit Breakers up to 6300 A (AC)

General data

Design

	Circuit breaker rated current $I_{n\max}$ (A)	Breaking capacity I_{cu} at 500 V AC (kA) or I_{cc} at 300 V DC (kA)	Dimensions		
			Fixed-mounted, 3- /4-pole	With-drawable 3- /4-pole	
Size III			704 / 914	704 / 914	Width
	434 / 434		460 / 460	Height	
	291 / 291		385 / 385	Depth	
Size II			460 / 590	460 / 590	Width
	434 / 434		460 / 460	Height	
	291 / 291		385 / 385	Depth	
Size I			320 / 410	320 / 410	Width
	434 / 434		460 / 460	Height	
	291 / 291		385 / 385	Depth	

The dimension for the depth of the circuit breaker is from the circuit breaker rear to the inner surface of the closed switchgear door.

NSE0_00887p

Overview of 3WL circuit breakers/non-automatic air circuit breakers

Versions

- Rated currents: 630 A to 6300 A
- 3 sizes for different rated current ranges (see above illustration)
- 3 and 4-pole versions
- Rated operational voltage up to 690 V AC and 1000 V DC. Special versions up to 1000 V AC and 1150 V AC available
- 4 different switching capacity classes in the range from 55 kA to 150 kA for AC applications and one switching capacity class for DC applications.

The 3WL circuit breakers are supplied complete with operating mechanism (manual operating mechanism with mechanical closing), electronic release and auxiliary switches (2 NO contacts + 2 NC contacts in the standard version), and can be equipped with auxiliary releases.

Installation types

Fixed-mounted or withdrawable version

Ambient temperatures

The 3WL circuit breakers are climate-proof according to IEC 60068-2-30. They are intended for use in enclosed areas where no severe operating conditions (e. g. dust, corrosive vapors, damaging gases) are present.

When installed in dusty and damp areas, suitable enclosures must be provided.

Coordinated dimensions

The dimensions of 3WL circuit breakers only differ in terms of the width of the device which depends on the number of poles and the size.

Due to the nature of the design, the dimensions of devices with a withdrawable version are determined by the dimensions of the guide frames, which are slightly larger.

Non-automatic air circuit breakers

One special version of circuit breaker is utilized as a non-automatic air circuit breaker. The non-automatic air circuit breakers are designed without an electronic release system and do not perform any protection function for the system.

One potential application is the use as a bus coupler in systems with parallel feed-ins.

The versions and features can be selected according to those of the circuit breakers.

Operating mechanisms

The circuit breakers are available with various optional operating mechanisms:

- Manual operating mechanism with mechanical closing (standard design)
- Manual operating mechanism with mechanical and electrical closing
- Motorized operating mechanism with mechanical and electrical closing

The operating mechanisms with electrical closing can be used for synchronization tasks.

3WL Air Circuit Breakers/Non-Automatic Air Circuit Breakers up to 6300 A (AC)

General data

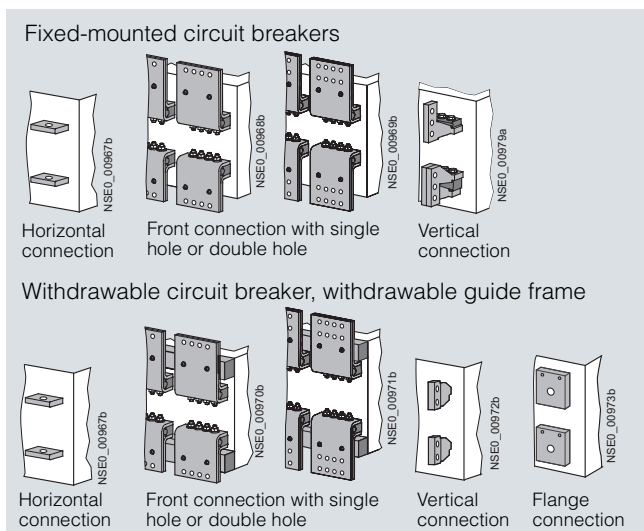

Main circuit connections – connection types

Main circuit connections

All circuit breakers are equipped with horizontal main circuit connections on the rear for up to 5000 A as standard (horizontal connection to busbars). Exception: Circuit breakers of size II with max. rated current 4000 A.

Circuit breaker with a maximum rated current of 6300 A and circuit breaker of the size II with a maximum rated current of 4000 A are equipped with vertical main connections (for upright busbars).

The following options are available, with all combinations of top and bottom connections possible:

- Accessible from the front, single hole (for vertically installed busbars)
- Accessible from the front, double hole (holes according to DIN 43673) (for vertically installed busbars)
- At the rear, vertical (for vertically installed busbars)
- Connecting flange (for direct connection to guide frame up to 4000 A).

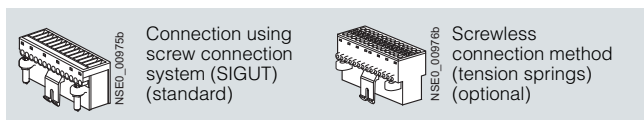

Connection options for auxiliary circuit connections

Auxiliary circuit connections

The type of connection for the auxiliary switches depends on the installation type:

- **Withdrawable version:** The internal auxiliary switches are connected to the male connector on the switch side. When fully inserted, the connector makes a connection with the sliding contact module (see the graphic "Guide Frame" in "Design") in the guide frame. Various adapters can then be used to complete the wiring (see the graphic "Connection Options for Auxiliary Circuit Connections").
- **Fixed mounting:** In this case the auxiliary supply connectors are engaged directly onto the circuit breaker. The connectors are equipped with coding pins that prevent them being mistakenly interchanged.

Operator panel

The operator panel is designed to protrude from a cutout in the door providing access to all control elements and displays with the control cabinet door closed.

The operator panels for all circuit breakers (fixed-mounted/withdrawable versions, 3-/4-pole) are identical. The operator panel ensures degree of protection IP41.

Safety and reliability

The system contains many blocking devices to protect the circuit breakers and plant against unauthorized switching and to protect maintenance and operator personnel from danger. Others can be retrofitted.

Other safety features include:

- Infeed from above or below, as required
- Locking of the guide frame with the circuit breaker removed, as standard
- Locking of the withdrawable circuit breaker against movement, as standard
- High degree of protection with cover IP55
- Mechanical reclosing lockout after overload or short-circuit release as standard
- The circuit breaker is always equipped with the required number of auxiliary supply connectors

Standard versions

3WL circuit breakers are equipped with the following features as standard:

- Mechanical ON pushbutton and mechanical OFF pushbutton
- Manual operating mechanism with mechanical closing
- Switch position indication
- Ready-to-close indicator
- Memory status indicator
- Auxiliary switch 2 NO + 2 NC
- Rear horizontal main connectors for fixed mounting and for withdrawable version up to 5000 A, and rear vertical main connections at 6300 A and size II with 4000 A
- For 4-pole circuit breakers, the fourth pole (N) is installed on the left and is 100 % loadable with the rated current
- Contact erosion indicator for the main contacts
- Auxiliary circuit plug-in system with SIGUT screw terminals. Delivery inclusive of all auxiliary circuit connectors to internal features including coding device for the prevention of incorrect installation of auxiliary supply connectors for fixed-mounted circuit breakers
- Mechanical "tripped" indicator for electronic release system
- Mechanical reclosing lockout after tripping operation
- Operator panel cannot be taken off with the circuit breaker in the ON position

Additional features of the withdrawable version:

- **Main contacts:** Laminated receptacles in the guide frame, penetration blades on the withdrawable circuit breaker
- Position indicator in the operator panel of the withdrawable circuit breaker
- Captive manual crank handle for moving the withdrawable circuit breaker
- Guide frame with guide rails for easy moving of the withdrawable circuit breaker
- The withdrawable circuit breaker can be locked to prevent it being pushed out of position
- The withdrawable circuit breaker cannot be moved when it is in the ON position
- Coding of the rated current between the guide frame and the withdrawable circuit breaker

Standards

3WL circuit breakers comply with:

- IEC 60947-2
- Climate-proof according to IEC 60068-2-30.

Versions according to UL 489 also available, see [Catalog LV 16](#). Additional standards: www.siemens.com/lowvoltage/support or www.siemens.com/lowvoltage/configurators.

3WL Air Circuit Breakers

3WL Air Circuit Breakers/Non-Automatic Air Circuit Breakers up to 6300 A (AC)

General data

Withdrawable short-circuit, grounding, and bridging units

Portable positively-driven grounding and short-circuit devices are used for the disconnected system sections to verify isolation from the supply at the workplace.

Withdrawable grounding units allow simple and comfortable grounding. They are simply inserted into the guide frames in place of the corresponding withdrawable circuit breakers. This ensures that these devices are always first connected with the grounding electrode and then with the components to be grounded.

The grounding contacts are fitted to the side of the switch enclosure and establish the connection when inserted into the guide frame.

Short-time current of the grounding contact	kA	15 (500 ms)
Rated operational voltage	V	1000 (690 for size I)
Standards		DIN VDE 0683

All withdrawable terminals are short-circuited and grounded on delivery.

They are easily converted into withdrawable bridging units by qualified electricians according to the enclosed instructions.

In addition, the withdrawable unit can be adapted to various rated currents of a size.

Withdrawable short-circuit and grounding unit

The withdrawable short-circuit and grounding unit consists of a breaker enclosure with penetration blades which are connected with the short-circuiting link.

Depending on the version, the short-circuiting links are arranged at the top and/or bottom. The grounding and short-circuit connections are established when the device is inserted.

It must be ensured that the side to be short-circuited and grounded is not live. For this reason it is recommended that the withdrawable unit is only wound in when the door is closed.

Withdrawable bridging unit

The withdrawable bridging unit consists of a breaker enclosure in which all disconnection components and the operating mechanism have been replaced with simple connections between the upper and lower contacts.

Auxiliary releases

Up to two auxiliary releases can be installed at the same time. The following are available:

- 1 shunt release
- or 1 undervoltage release
- or 2 shunt releases
- or 1 shunt release
- + 1 undervoltage release.

Signaling switch for auxiliary releases

One signaling contact is used for each auxiliary release to determine the switch positions of the auxiliary releases.

Shunt release

When the operational voltage is connected to the shunt release, the circuit breaker is opened immediately. The shunt release is available in the versions 5 % OP for over-excitation and 100 % OP for permanent excitation. This means that it is also possible to block the circuit breaker against being jogged into closing.

An energy storage device for shunt releases allows the circuit breaker to be opened even if the control voltage is no longer available.

Undervoltage release

The undervoltage release causes the circuit breaker to be opened if the operational voltage falls below a certain value or is not applied. The circuit breaker cannot be closed manually or by means of an electrical ON command if the undervoltage release is not connected to the operational voltage. The undervoltage release has no delay as standard. A delay can be set by the customer in the range between $t_d < 80$ ms and $t_d < 200$ ms.

In addition, an undervoltage release with a delay in the range from 0.2 to 3.2 s is available.

Closing solenoid

The closing solenoid is used to close the circuit breaker electrically by means of a local electrical "ON" command or by a remote unit.

Motorized operating mechanism

The operating mechanism is used to load the storage spring automatically.

The operating mechanism is activated if the storage spring has been unloaded and the control voltage is available.

It is switched off automatically after loading. This does not affect manual operation of the storage spring.

Indicators, signals, and control elements

Motor shutdown switch

Control switch for switching off the motorized operating mechanism (automatic loading).

Operating cycles counter

The motorized operating mechanism can be supplied with a 5-digit operating cycles counter. The display is incremented by "1" as soon as the storage spring is fully loaded.

Resetting the manual tripped signal

When the circuit breaker has tripped, this is indicated by the protruding red mechanical tripped indicator on the ETU. When the mechanical tripped indicator is activated, the tripping solenoid and tripped signal are reset. If this display is to be reset remotely, the reset button can be equipped with a reset solenoid.

This option allows the circuit breaker to be reset both manually and electrically.

Automatic resetting of reclosing lockout

When the ETU is activated, reclosing of the circuit breaker is prevented until the release is either electrically or manually reset. If the "Automatic resetting of reclosing lockout" option is used, the pre-tensioned circuit breaker is ready to close immediately after tripping. Resetting the manual tripped indicator is not included in this option.

Tripped signaling switch

If the circuit breaker has tripped due to an overload, short-circuit, ground fault or extended protection function, the tripped signaling switch can indicate this. This signaling switch is available as an option. If the circuit breaker is used for communication, this option is supplied as standard.

Ready-to-close signaling switches

The 3WL circuit breakers are equipped with an optical ready-to-close indicator as standard. In addition, the ready-to-close status can be transmitted by means of a signaling switch as an option. If the switch is used for communication, the signaling switch is supplied as standard.

3WL Air Circuit Breakers

3WL Air Circuit Breakers/Non-Automatic Air Circuit Breakers up to 6300 A (AC)

General data

Circuit breakers

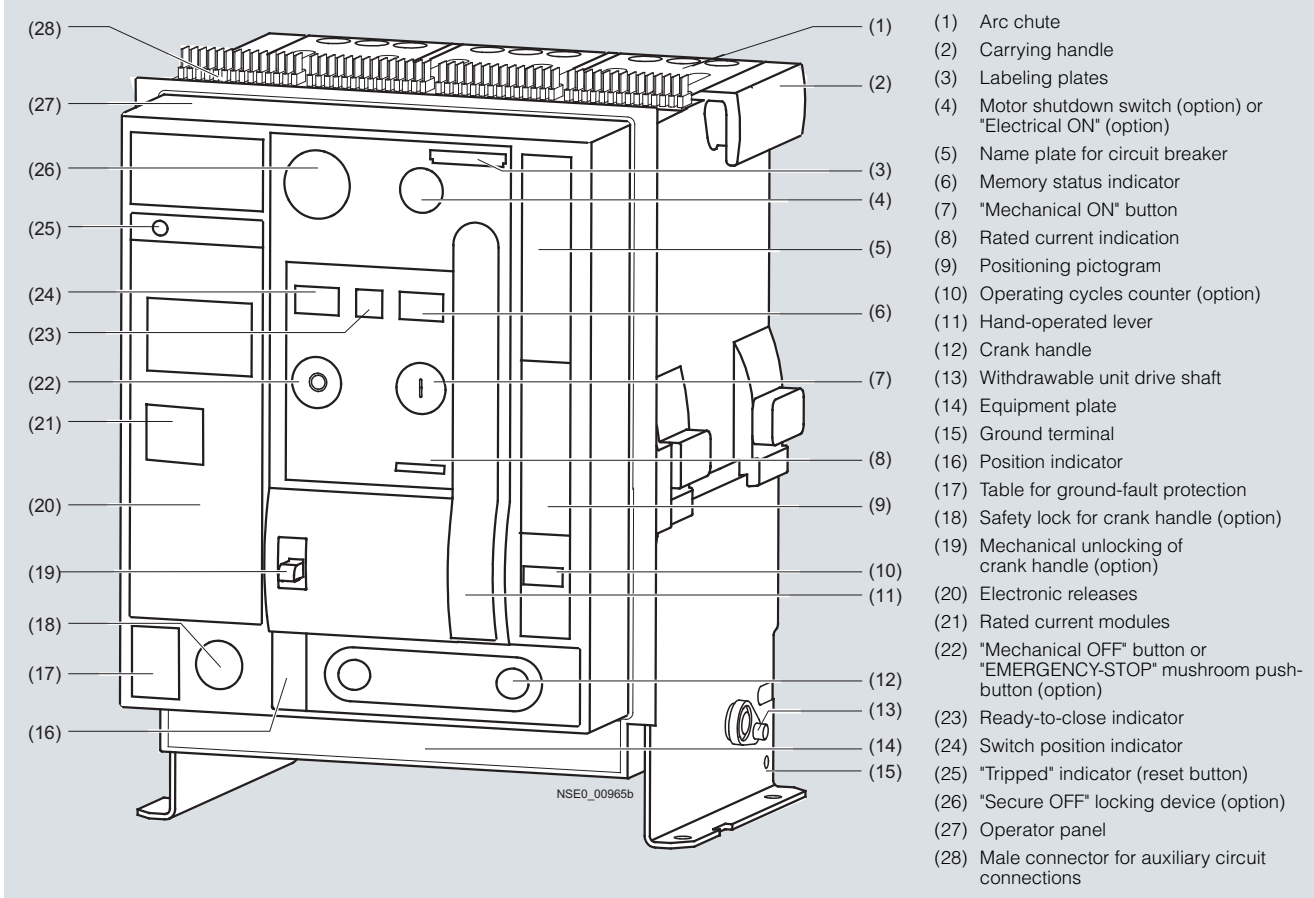

Guide frames

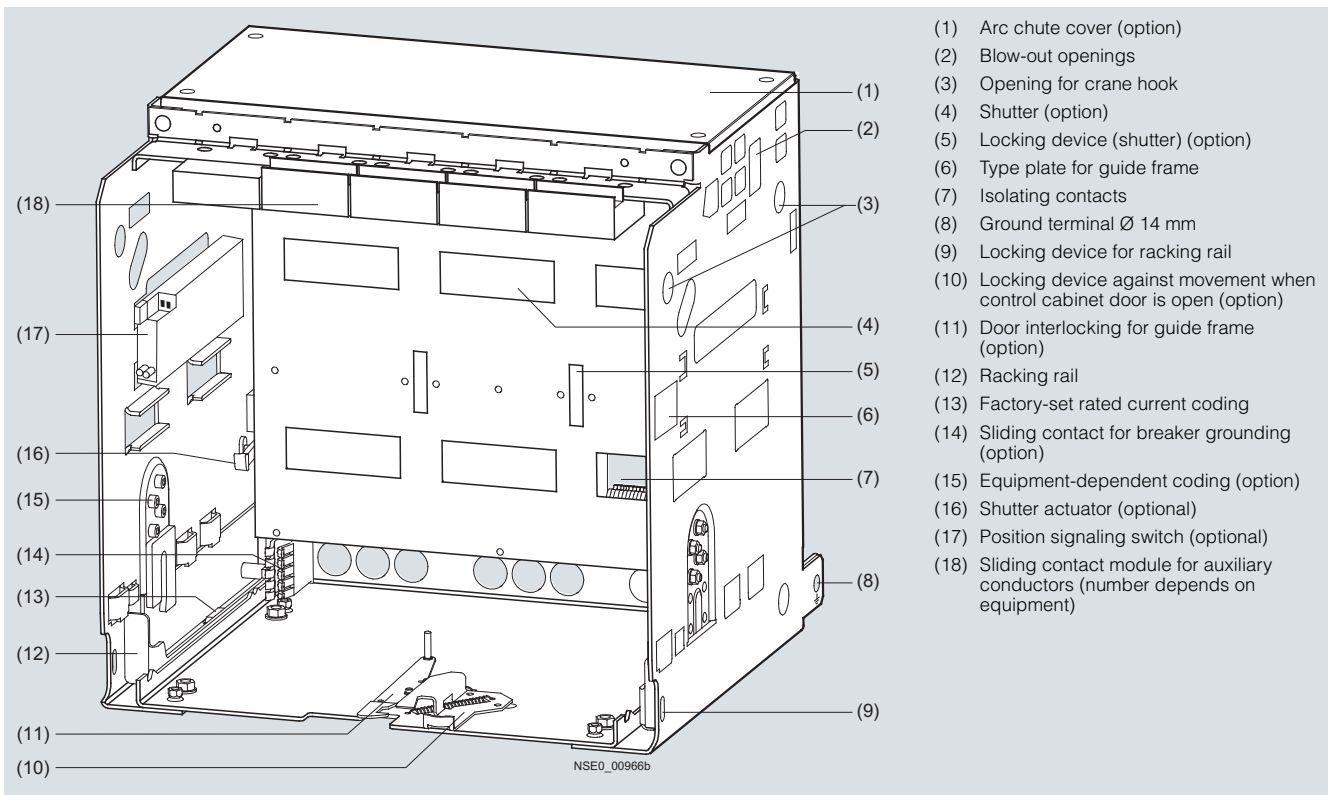

3WL Air Circuit Breakers

3WL Air Circuit Breakers/Non-Automatic Air Circuit Breakers up to 6300 A (AC)

General data

Locking devices

Locking device in OFF position

This function prevents closing of the circuit breaker and complies to the specifications for main switches according to EN 60204 (VDE 0113) - disconnecter unit. This lockout only affects this circuit breaker.

If the circuit breaker is replaced, closing is no longer prevented unless the new circuit breaker is also protected against unauthorized closing.

To activate the locking device, the circuit breaker must be opened. The locking device is disabled when the circuit breaker is closed. The lock is only activated when the key is removed. The safety key can be removed only in the "OFF" position.

Locking device for "Electrical ON"

(see graphic "Circuit breakers")

This prevents unauthorized electrical closing from the operator panel. Mechanical closing and remote closing remain possible. The lock is only activated when the key is removed.

Locking device for "Mechanical ON"

(see graphic "Circuit breakers")

This prevents unauthorized mechanical closing. The mechanical ON button can only be activated if the key is inserted (key operation). Closing with the "Electrical ON" button and remote closing remain possible. The lock is only activated when the key is removed.

"Secure OFF" circuit breaker-independent locking device against unauthorized closing

This special switch-independent function for withdrawable circuit breakers prevents closing and fulfills the specifications for main switches to EN 60204 (VDE 0113) – disconnecter unit. Unauthorized closing remains impossible even after the circuit breaker has been exchanged.

To activate the lock, the circuit breaker must be opened. The locking device is disabled when the circuit breaker is closed. The lock is only activated when the key is removed. The safety key can be removed only in the "OFF" position.

Locking device for crank handle

Prevents removal of the crank. The circuit breaker is protected against movement. The lock is only activated when the key is removed.

Locking device for "Mechanical OFF"

Prevents unauthorized mechanical opening from the operator panel. The "Mechanical OFF pushbutton" can only be activated if the key is inserted (key operation). Remote opening remains possible. The lock is only activated when the key is removed.

Locking device for hand-operated lever

The hand-operated lever can be locked with a padlock. The storage spring cannot be loaded manually.

Locking device against resetting the "tripped" indicator

A lockable cover prevents manual resetting of the "tripped" indicator after overcurrent tripping. This locking device is supplied together with the transparent cover for electronic releases.

Sealing devices

Sealing cap for "Electrical ON" button

The "Electrical ON button" is equipped with a sealing cap as standard.

Sealing cap for "Mechanical ON button" and "OFF"

The interlocking set contains covering caps which can be sealed.

Sealing device for electronic releases

The transparent cover can be sealed. The parameter setting ranges are covered to prevent unauthorized access. Openings allow access to the query and test button.

Locking mechanisms

Locking device against movement for withdrawable circuit breakers when the control cabinet door is open

The crank handle is blocked when the control cabinet door is open and cannot be removed. The withdrawable circuit breaker cannot be moved. The lock only affects the inserted crank handle.

Interlocking of the control cabinet door

The control cabinet door cannot be opened if

- The fixed-mounted circuit breaker is closed (the blocking signal is transmitted via the Bowden wire) or
- The withdrawable circuit breaker is in the connected position.

Blocking mechanism using "Mechanical ON" and "OFF" buttons

The "Mechanical ON" and "OFF" buttons are covered with a cap which only allows actuation with a tool. These covering caps are part of the interlocking set.

Accessories for guide frames

Shutters

The sealing strips of the shutter seal the laminated contacts of the guide frame when the withdrawable circuit breaker is removed and therefore implement touch protection.

The sealing strips can be manually opened using the strip levers.

The position of the sealing strips can be locked in various positions using padlocks for securing against tampering.

3WL Air Circuit Breakers/Non-Automatic Air Circuit Breakers up to 6300 A (AC)

General data

Rated current coding unit between circuit breaker and guide frame

Withdrawable circuit breakers and guide frames are equipped with a rated current coding unit as standard.

This ensures that only circuit breakers whose penetration blades are suited to the laminated contacts of the guide frame can be inserted into a guide frame (see diagram below).

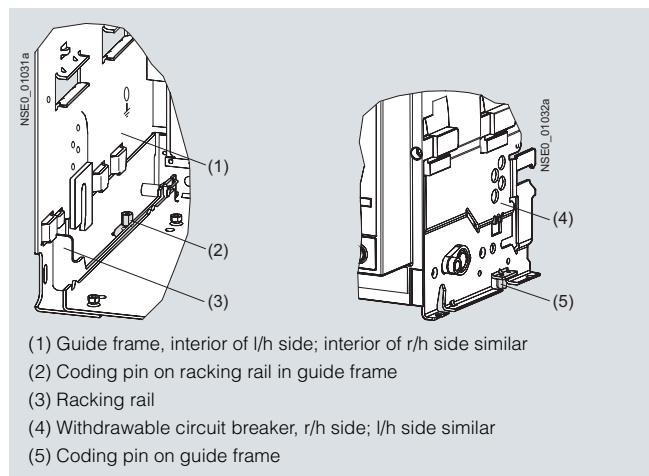

Rated current coding unit between circuit breaker and guide frame

Equipment-dependent coding

Withdrawable circuit breakers and guide frames can be retrofitted with an equipment-dependent coding unit.

This allows different designs of circuit breakers and guide frames to be uniquely assigned. If the circuit breaker and guide frame have been assigned different codes, the circuit breaker cannot be inserted.

36 different coding options can be selected.

Position signaling switches for guide frames

The guide frame can be equipped with position signaling switches. These can be used to determine the position of the circuit breaker in the guide frame.

Two versions are available:

- Option 1
 Connected position 1 CO contact,
 Test position 1 CO contact,
 Disconnected position 1 CO contact;
- Option 2
 Connected position 3 CO contacts,
 Test position 2 CO contacts,
 Disconnected position 1 CO contact.

Positions of the withdrawable circuit breaker in the guide frame

	presenting	Position indicator	Main circuit	Auxiliary circuit	Control cabinet door	Shutters
Maintenance position			Disconnected	Disconnected	Open	Closed
Disconnected position			Disconnected	Disconnected	Closed	Closed
Test position			Disconnected	Connected	Closed	Closed
Connected position			Connected	Connected	Closed	Open

(1) Auxiliary circuit (2) Main circuit (3) Control cabinet door (4) Shutter

Phase barriers

The plant engineering company can manufacture phase barriers made of insulating material for the arcing fault barriers. The rear panel of the fixed-mounted circuit breakers or guide frames are equipped with guide grooves.

Arc chute covers

The arc chute cover is available as accessory for the guide frame. It protects switchgear components which are located directly above the circuit breaker.

Door sealing frame and cover

3WL circuit breakers have degree of protection IP20 as standard. However, if the switchgear is to be equipped with a higher degree of protection, a door sealing frame with IP41 and a cover with IP55 are available.

3WL Air Circuit Breakers

3WL Air Circuit Breakers/Non-Automatic Air Circuit Breakers up to 6300 A (AC)

General data

Function

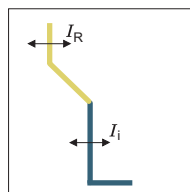
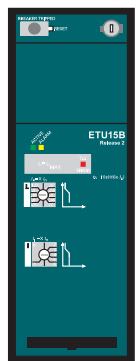

NSE0_00950c

ETU15B

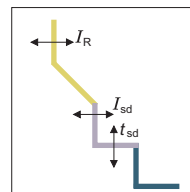
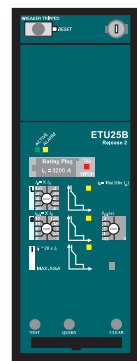

NSE0_00951b

ETU25B

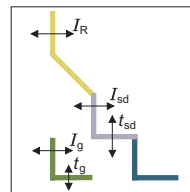
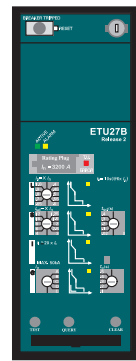

NSE0_00952b

ETU27B

Functions of the electronic releases

Basic protection functions

Overload protection	L	✓	✓	✓
Short-time delayed short-circuit protection	S	--	✓	✓
Instantaneous short-circuit protection	I	✓	✓	✓
Neutral conductor protection	N	--	--	✓
Ground-fault protection	G	--	--	✓

Additional functions

N-conductor protection can be switched on/off		--	--	✓
N-conductor protection adjustable		--	--	--
Short-time delayed short-circuit protection can be switched on/off		--	--	--
Instantaneous short-circuit protection can be switched on/off		--	--	--
Thermal image can be switched on/off		--	--	--
Load monitoring		--	--	--
Short-time delayed short-circuit protection switchable to I^2t		--	--	--
Instantaneous short-circuit protection adjustable		✓	--	--
Overload protection switchable to I^4t		--	--	--
Overload protection can be switched on/off		--	--	--
Selectable parameter sets		--	--	--

Parameterization and display

Parameterization through rotary coding switches (10 steps)		✓	✓	✓
Parameterization through communication (absolute values)		--	--	--
Parameterization through user interface of ETU (absolute values)		--	--	--
Parameterization of the extended protection functions		--	--	--
LCD alphanumerical		--	--	--
Graphic LCD		--	--	--

Measurement function

Measurement function <i>Plus</i>		--	--	--
----------------------------------	--	----	----	----

Communication

CubicleBUS		--	--	--
Communication through PROFIBUS DP		--	--	--
Communication through MODBUS		--	--	--
Communication through Ethernet		--	--	--

✓ Standard -- Not available □ Optional

[Detailed information about the functions of the electronic releases is given in the following.](#)

3WL Air Circuit Breakers

3WL Air Circuit Breakers/Non-Automatic Air Circuit Breakers up to 6300 A (AC)

General data

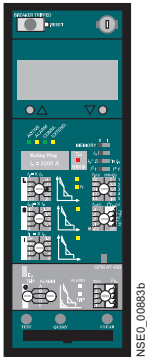

NSE0_00885b

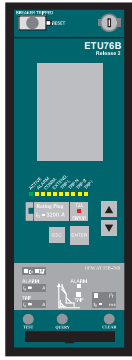

NSE0_00886c

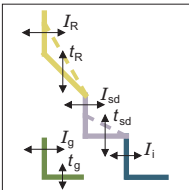

NSE0 00953a

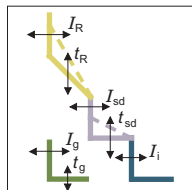

NSE0 00953a

ETU45B

ETU76B

	ETU45B	ETU76B
	✓	✓
	✓	✓
	✓	✓
	✓	✓
	□	□
	✓	✓
	✓	✓
	✓	✓
	✓	✓
	✓	✓
	✓	✓
	✓	✓
	✓	✓
	--	✓
	--	✓
	✓	--
	--	✓
	--	✓
	□	□
	□	--
	--	✓
	□	□
	✓	✓
	□	□
	□	□
	□	□

3WL Air Circuit Breakers

3WL Air Circuit Breakers/Non-Automatic Air Circuit Breakers up to 6300 A (AC)

General data

Electronic releases (ETU)

The electronic release is controlled by a microprocessor and operates independently of an auxiliary voltage. It enables systems to be adapted to the different protection requirements of distribution systems, motors, transformers and generators.

Communication capability

The international standard PROFIBUS DP or MODBUS can be used to transmit data such as current values, switching states, reasons for tripping etc. to central computers.

Data acquisition and energy management are possible in conjunction with the *Plus* measurement function.

A new internal circuit breaker data bus allows switchboard panel communication between the circuit breaker and secondary devices in the circuit breaker section:

- Actuation of analog displays
- Facility to test the communication build-up with circuit breakers
- Display of tripping state and tripping reasons
- Input module for reading in further switchgear panel signals and for transmission of these signals to the PROFIBUS DP or MODBUS
- Various output modules for displaying measured values.

This means that it is not only possible to monitor the device remotely, but also to transmit current values from the entire system and perform switching operations remotely.

I^2t and I^4t characteristic curve for overload protection

The best protection for the whole switchgear is achieved by setting the tripping characteristic curve to an optimum value. In order to achieve optimal discrimination for upstream fuses or medium voltage protection systems, the inclination of the characteristic curve can be selected for the overload range.

The overload protection L (long time protection) for the electronic releases ETU45B and ETU76B allows the characteristic curve to be switched between I^2t and I^4t .

The I^4t characteristic improves discrimination for downstream circuit breakers and fuses.

Electronic releases ETU

Modularity has also been strictly emphasized during the development of the electronic releases. These are some of the modules which can be easily retrofitted at any time:

- Ground-fault protection module
- Communication
- Measurement function
- Display
- Rated current module (Rating Plug)

This allows quick adaptation to new local mains specifications. In addition, innovative functions have been included in the ETUs.

Rated current module/Rating Plug

The rated current module is an exchangeable module which allows the user to reduce the rated device current so as to adapt it optimally to the plant; e.g. if a new plant section is taken into operation. The rated current module must be selected to fit the rated current of the plant.

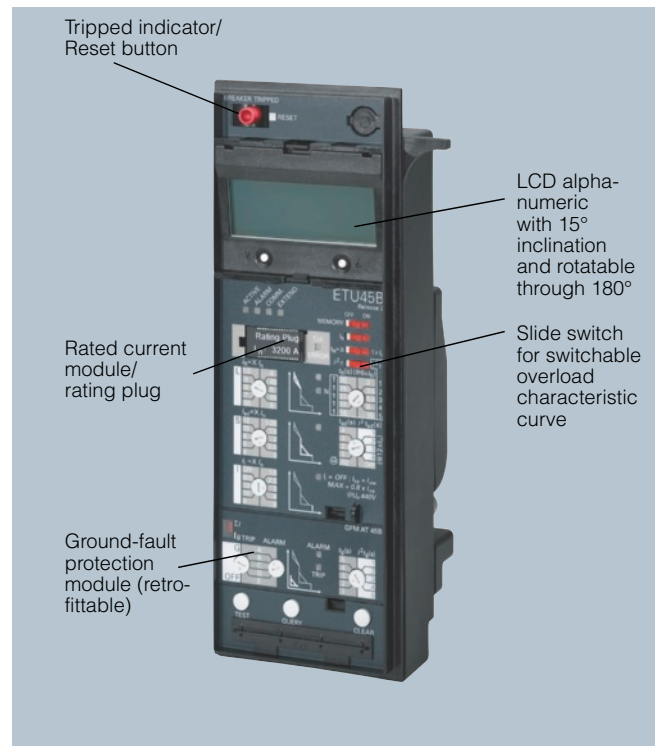

Example of configuration for ETU45B



Measurement function *Plus*

Selectable parameters

In the case of quick changes of power supply conditions, e. g. for switchovers from transformer to generator operation or if a section of the supply is disconnected when the shift changes, the 3WL circuit breaker allows the relevant protection parameters to be quickly adapted to the new conditions. The ETU76B contains two independent tripping characteristic curves (parameter sets). The switchover is completed within 200 ms and is performed with the help of an external signal.

3WL Air Circuit Breakers

3WL Air Circuit Breakers/Non-Automatic Air Circuit Breakers up to 6300 A (AC)

General data

ETU15B electronic release

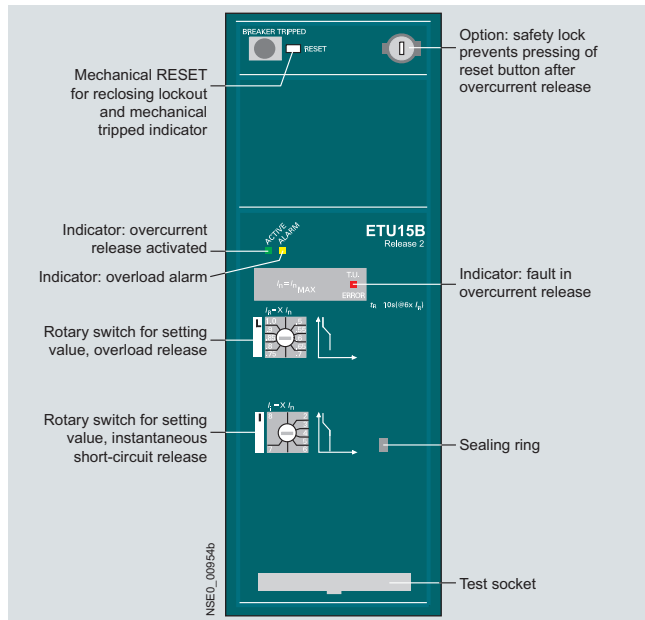

Application:

Simple building and system protection without time-selective coordination up to 4000 A. Not to be used for size III.

Features:

- Adjustable overload protection with I^2t characteristic curve with preset delay time
 $t_R = 10$ seconds at $6 \times I_R$
- Instantaneous short-circuit protection adjustable in the range $2 \dots 8 \times I_n$
- Overload display
- Protection function is set by means of the rotary coding switch

For technical details see the table "Functional Overview of the Electronic Release System" under "Technical Specifications".

ETU25B electronic release

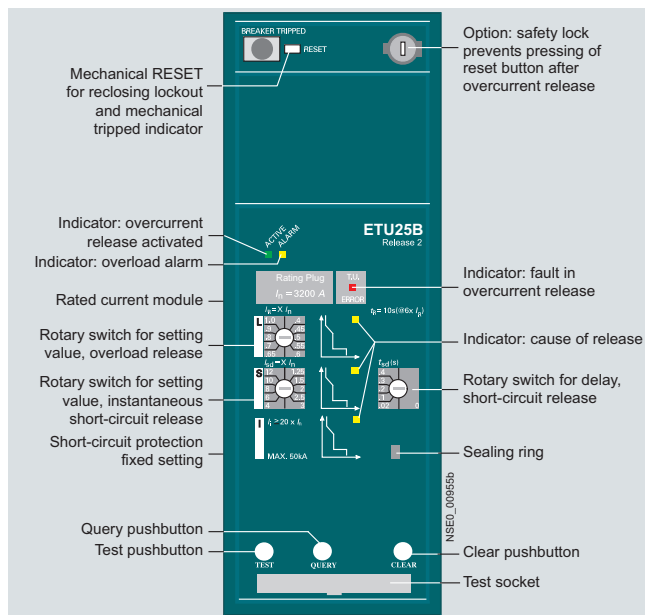

Application:

Classical building, motor and system protection with time-selective coordination for up to 6300 A

Features:

- Adjustable overload protection with I^2t -characteristic curve
Delay time
 $t_R = 10$ seconds at $6 \times I_R$
- Short-time delayed short-circuit protection adjustable in the range $1.25 \dots 12 \times I_n$ and
- Instantaneous short-circuit protection preset to $20 \times I_n$, max. 50 kA
- Can be adapted at any time to the required plant currents through retrofittable rated current module, thus ensuring overload protection in the range from 100 A to 6300 A.
- Overload display
- Indicates the reason for tripping by means of an LED
- Test facility for the release
- Protection functions are set by means of the rotary coding switch

For technical details see the table "Functional Overview of the Electronic Release System" under "Technical Specifications".

3WL Air Circuit Breakers

3WL Air Circuit Breakers/Non-Automatic Air Circuit Breakers up to 6300 A (AC)

General data

ETU27B electronic release

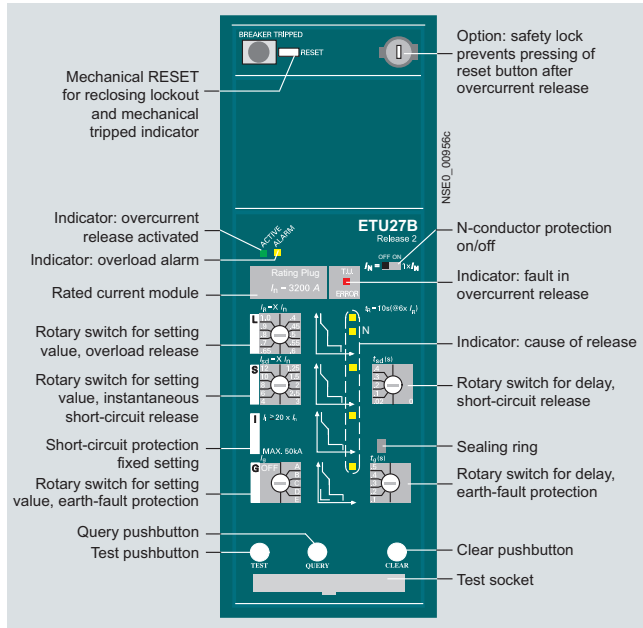

Application:

Classical building, motor and system protection with time-selective coordination for up to 6300 A

Features:

The same as ETU25B but also

- Reversible neutral conductor protection
- Permanently integrated ground-fault protection. Calculation of the ground-fault current through vectorial summation current formation

For technical details see the table "Functional Overview of the Electronic Release System" under "Technical Specifications".

ETU45B electronic release

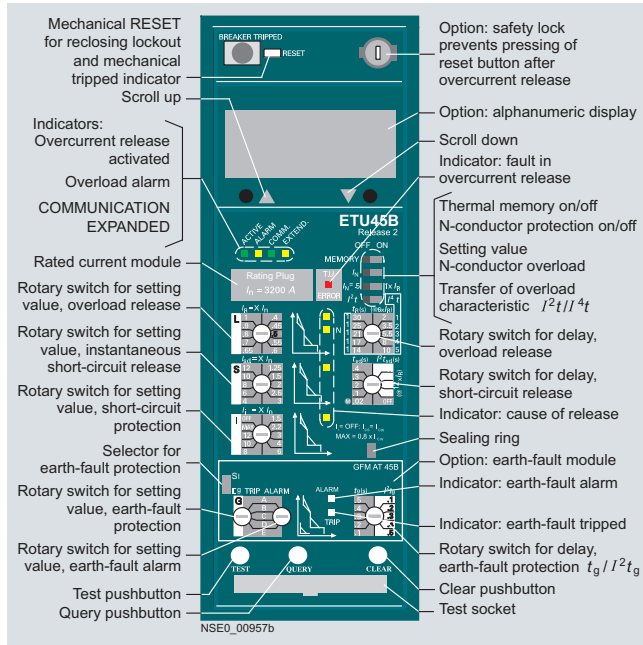

Application:

Low-cost all-round system for intelligent buildings and all types of industrial applications – "CubicleBUS integrated"

Features:

The same as ETU25B but also

- Adjustable time-lag class for overload protection
- Selectable characteristic for overload and short-delayed short-circuit range (current discrimination) for more accurate discrimination adaptation to upstream fuses and protective devices
- Thermal image as restart protection for tripped motor outgoing feeders
- Reversible and adjustable neutral conductor protection
- Modular ground-fault protection module with alarm and tripping functions which can be adjusted separately
- Communication interface, measurement function *Plus*, optional connection of external modules or for retrofitting
- Storage of events and causes for tripping for detailed fault analysis
- Extended protection function possible with measurement function
- Optional high-contrast display with viewing angle adjustment option
- The protection functions can be set by means of a rotary coding switch or slide switch

For technical details see the table "Functional Overview of the Electronic Release System" under "Technical Specifications".

3WL Air Circuit Breakers

3WL Air Circuit Breakers/Non-Automatic Air Circuit Breakers up to 6300 A (AC)

General data

ETU76B electronic release

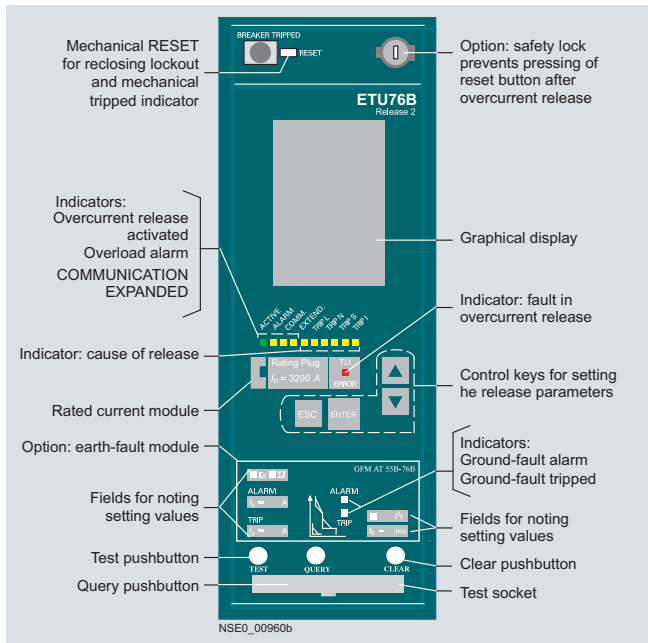

Application:

The multi-talent with graphical display for system analysis – "CubicleBUS integrated"

Features:

The same as ETU45B but also including

- Two protection parameter sets which can be stored separately in the release (switchover is performed by means of external signal)
- With overload protection which can be deactivated for operation in modern drive technology
- Adjustable delay of delayed short-circuit protection up to 4000 ms
- Neutral conductor protection adjustable up to $I_N = 200\% I_N$
- Setting of protection functions by means of Breaker Data Adapter (BDA) or via communications interface
- Graphical display of all parameters and events/curve trends
- Graphics display with high contrast, backlit display, and sleep mode.

For technical details see the table "Functional Overview of the Electronic Release System" under "Technical Specifications".

Ground-fault protection

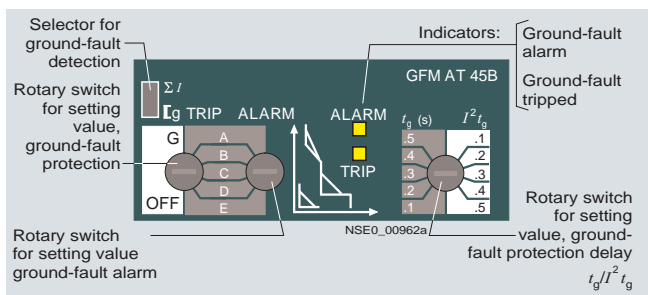

GFM AT 45B ground-fault module

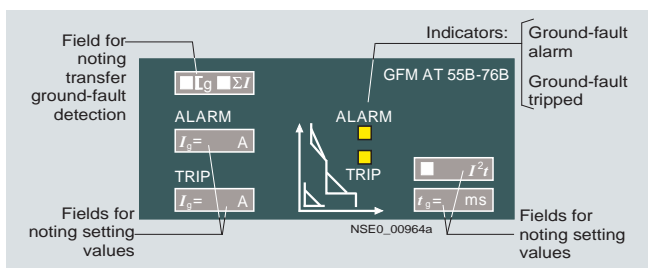

GFM AT 55B-76B ground-fault module

Ground-fault releases "G" sense fault currents that flow to ground and that can cause fire in the plant. Multiple circuit breakers connected in series can have their delay times adjusted so as to provide graduated discrimination.

When setting the parameters for the electronic release it is possible to choose between "alarm" and "trip" in the event that the set current value is exceeded. The reason for tripping is indicated by means of an LED when the query button is activated.

The ETU45B and ETU76B electronic release versions can be retrofitted with a ground-fault protection module. This ground fault protection function is integrated in ETU27B electronic releases.

3WL Air Circuit Breakers

3WL Air Circuit Breakers/Non-Automatic Air Circuit Breakers up to 6300 A (AC)

General data

Measurement method

Vectorial summation current formation (measurement method 1)

The three phase currents and the N conductor current are measured directly.

The electronic release determines the ground-fault current by means of vectorial summation current formation for the three phase currents and the N conductor current.

Direct measurement of the ground-fault current (measurement method 2)

A standard current transformer with the following data is used for measurement of the ground-fault current:
1200 A/1 A, Class 1 (the internal load of the 3WL circuit breaker is 0.11 Ω). The current transformer can be installed directly in the grounded neutral point of a transformer.

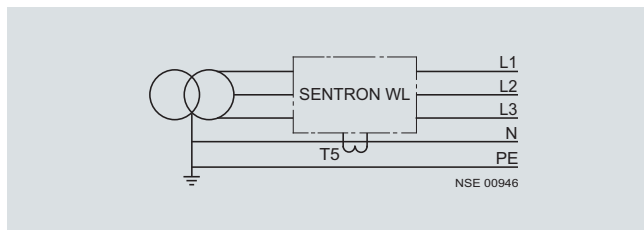

3-pole circuit breakers, current transformers in the N conductor

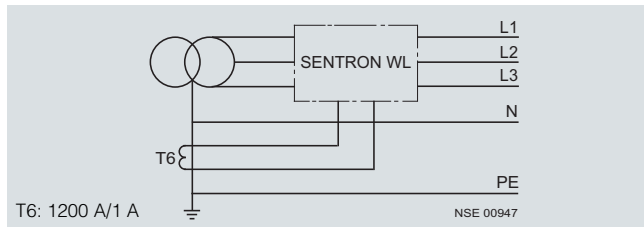

3-pole circuit breakers, current transformers in the grounded neutral point of the transformer.

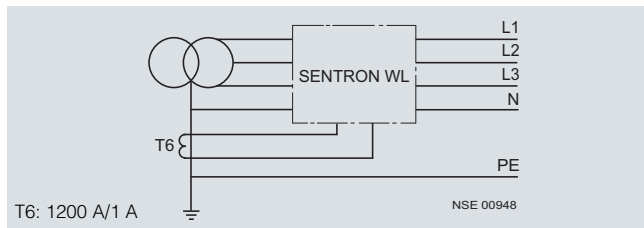

4-pole circuit breakers, current transformers in the grounded neutral point of the transformer.

Setting

How the module is set depends on the measurement method used (see above):

Measurement method 1: in position ΣI .

Measurement method 2: in position Γ_g .

This setting can be implemented for the electronic release version ETU76B with Menu/Comm.

Ground-fault protection with I^2t characteristic curve

With the exception of the ETU27B electronic release, all versions of the ground-fault modules are supplied with an I^2t characteristic curve which can be activated.

Selection criteria for 3WL circuit breakers

Basic criteria for selecting circuit breakers are:

- **Max. short-circuit current** at place of installation of circuit breaker I''_{kmax} .
This value determines the short-circuit breaking capacity or short-circuit current carrying capacity of the circuit breaker.
- It is compared with the value I_{cu} , I_{cs} , I_{cw} of the circuit breaker and essentially determines the size of the circuit breaker. See illustration "Overview of 3WL Circuit Breakers/Non-Automatic Air Circuit Breakers".
- **Rated current** I_n which is to flow through the branch circuit. This value must not be greater than the maximum rated circuit breaker current of the circuit breaker. The rated current for the 3WL circuit breaker is specified using the rated current module. See illustration "Overview of 3WL Circuit Breakers/Non-Automatic Air Circuit Breakers" in "Design".
- **Ambient temperature** for the circuit breaker. This is usually the control cabinet internal temperature.
- **Design** of the circuit breaker
- **Minimum short-circuit current** which flows through the switching device. The release must still detect this value as a short-circuit and must respond by tripping.

Protection functions of the circuit breaker.

These are determined by the selection of the corresponding electronic release, see the table "Functions of the Electronic Releases" under "Functions".

3WL Air Circuit Breakers

3WL Air Circuit Breakers/Non-Automatic Air Circuit Breakers up to 6300 A (AC)

General data

3WL circuit breakers for DC applications

This version of the 3WL non-automatic air circuit breaker is suitable for direct current applications. The external protective device DIGmat S100 provides adjustable overload and short-circuit protection for 3WL non-automatic air circuit breakers.

This is based on the measuring chain of a shunt resistor and the DIGmat S100 tripping unit. Shunt resistors are available for 1000 A, 2000 A and 4000 A (special ranges on request). They are in accordance with DIN 43703 and have a class accuracy of 0.5.

A measuring-circuit voltage of 60 mV DC is picked off for rated current I_N .

The measuring-circuit voltage is a linear image of the primary current.

The DIGmat S100 tripping unit monitors the image of the primary current thus supplied and compares it with the tripping characteristic curve set on the device. The parameter settings on the DIGmat S100 apply also for DC feedbacks. Reversing duty is possible therefore.

The tripping characteristic curve is determined and described by the following variables:

- Overload protection:
Setting range $I_R = 0.4 \dots 1.0 I_N$
The characteristic curve has an I^2t characteristic.
The tripping time t_R can be selected between 2 and 10 s, although t_R for $6 \times I_R$ is defined.

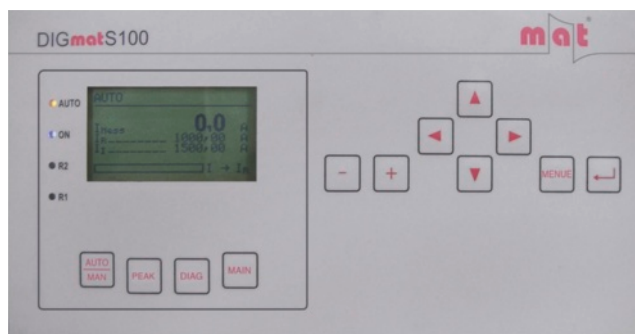

DIGmat S100

- Short-circuit protection:
Setting range $I_i = 1.25 \times I_R$ up to max. $4 \times I_N$
If the set value is exceeded, tripping occurs in less than 50 ms.

I_N = Rated current of the circuit breaker

I_R = Set current value of the adjustable overload release

t_R = Assigned tripping time of the overload trip

I_i = Instantaneous tripping current of the adjustable short-circuit releases

The components are available only from the company mat – Maschinen- und Anlagentechnik:

mat – Maschinen- und Anlagentechnik
Dr. Becker GmbH
Rudolf-Diesel-Straße 22
D-22941 Bargteheide
Tel.: +49 (4532) 20 21-01
Fax: +49 (4532) 20 21-21
E-mail: info@m-a-t.de
Internet: www.m-a-t.de

Configuration

Mutual mechanical circuit breaker interlocking

The module for mutual mechanical interlocking can be used for one or two 3WL circuit breakers and can be adapted easily to the corresponding versions. The fixed-mounted and withdrawable circuit breaker versions are fully compatible and can therefore be used in a mixed configuration in an installation. This also applies to 3WN6 circuit breakers.

The circuit breakers can be mounted alongside each other or one above the other, whereby the distance of the circuit breakers is determined solely by the length of the Bowden wire (lengths: 2 m/3 m/4.5 m). Interlock signals are looped through using the Bowden cables. Interlocking is only effective in the connected position in the case of withdrawable circuit breakers. The mechanical endurance of the Bowden cables is 10000 operating cycles.

Minimum requirements must be fulfilled in the switchgear for the interlocking to function:

- Bowden cables must be installed as far as possible in a straight line with minimum bending.

- The bending radii of the Bowden wire must be > 500 mm.
- The sum of all bending angles along the Bowden cable must not exceed 640° .
- In a vertical arrangement of circuit breakers to be interlocked, the interlocking mechanisms must be in line.
- Circuit breakers to be interlocked must be arranged so that Bowden cables can be optimally installed in compliance with the conditions mentioned in the above points.
- The installed Bowden cable must be fixed (with cable ties or the like) before the interlock is adjusted.
- Select the width of switchgear cubicle to allow enough freedom of movement for adjusting the interlock!
- Openings and cut-outs in system elements must be designed so that Bowden cables are not changed in direction or obstructed when they are passed through.

Mutual mechanical interlocking of circuit breakers – examples

Mutual interlocking of two circuit breakers	Interlocking between three circuit breakers	Mutual interlocking of three circuit breakers	Interlocking of three circuit breakers, two of them mutual
<p>NSE01041</p>	<p>NSE01042</p>	<p>NSE01044</p>	<p>NSE01045</p>

3WL Air Circuit Breakers

3WL Air Circuit Breakers/Non-Automatic Air Circuit Breakers up to 6300 A (AC)

General data

Communication-capable circuit breakers

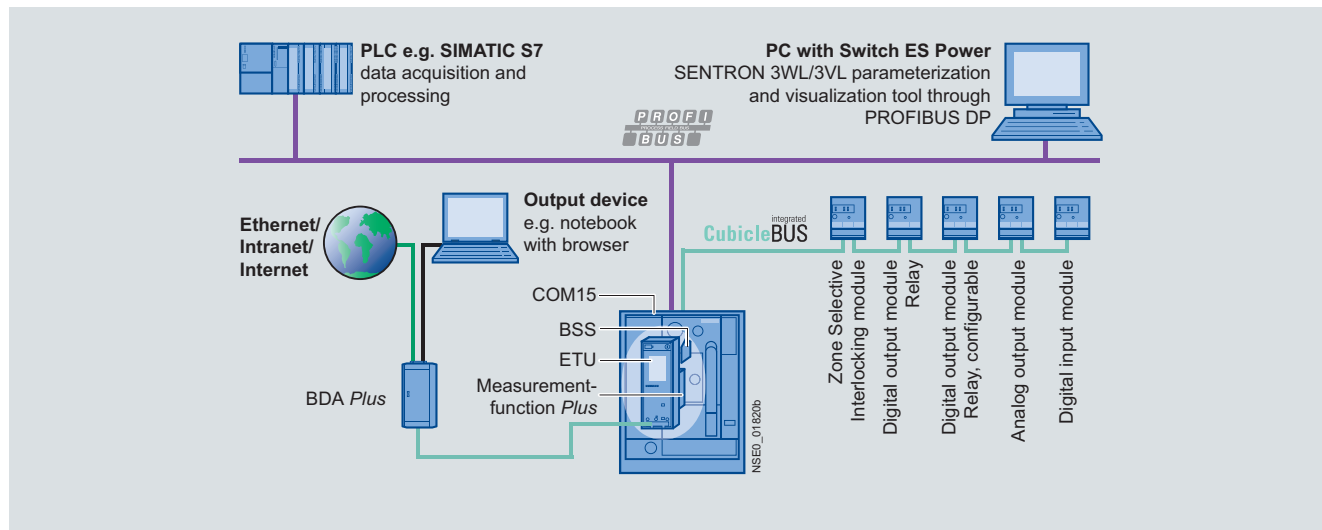

Communication with PROFIBUS DP

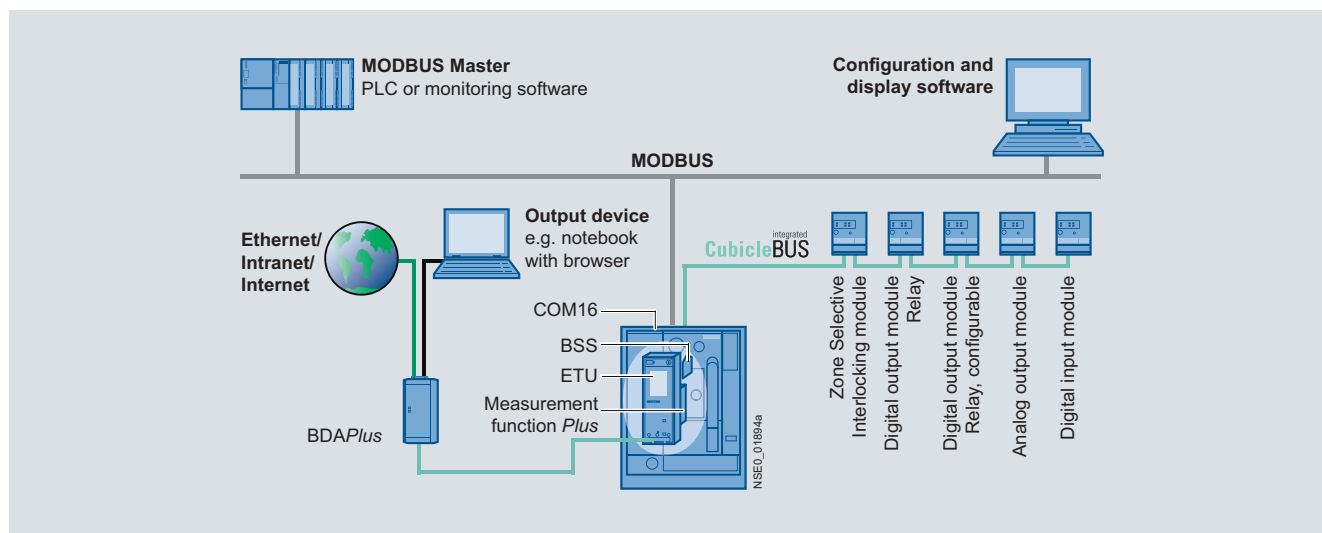

Communication with MODBUS

The requirements for power distribution in terms of communication capability, data transparency, flexibility and integration are constantly increasing. An integrated and modular communication architecture was designed for the 3WL circuit breaker to ensure that it can satisfy these requirements.

The core component of this architecture is the **CubicleBUS**, which links together all of the intelligent components within the 3WL circuit breaker and enables the easy and safe connection of other additional external components to the circuit breaker. The **CubicleBUS** is already incorporated and pre-connected in all complete circuit breakers with ETU45B and ETU76B releases.

The high level of modularity of the system allows communication functions to be retrofitted at any time (e. g. the measurement function). Similarly, the upgrade of a non-communication-capable 3WL circuit breaker (e. g. changeover from ETU25B to ETU45B with **CubicleBUS**) can be carried out easily on site in the plant. All modules connected to the **CubicleBUS** can directly access the existing source data of the circuit breaker, which guarantees the quickest possible access to information and response to events.

Furthermore, additional external modules (including digital inputs/outputs, analog outputs) can be connected to the **CubicleBUS** to provide cost-effective solutions for the automation of further devices in the switchgear.

3WL Air Circuit Breakers

3WL Air Circuit Breakers/Non-Automatic Air Circuit Breakers up to 6300 A (AC)

General data

Communication-capable 3WL circuit breakers

Function	Electronic release version		Breaker Status Sensor	PROFI-BUS communication port	Measurement function Plus	Analog output modules	Digital output module	Digital input module	ZSI module	Breaker Data Adapter Plus
	ETU45B	ETU76B								
Functions of the communication-capable 3WL circuit breakers										
Indication of measured values in release (current only)	✓	✓	<input type="checkbox"/>	<input type="checkbox"/>	<input type="checkbox"/>	<input type="checkbox"/>	<input type="checkbox"/>	<input type="checkbox"/>	<input type="checkbox"/>	<input type="checkbox"/>
Indication of measured values in release (U, I, P, S, Q, p.f., etc.)	✓	✓	<input type="checkbox"/>	<input type="checkbox"/>	✓	<input type="checkbox"/>	<input type="checkbox"/>	<input type="checkbox"/>	<input type="checkbox"/>	<input type="checkbox"/>
Indication of measured values (current only), parameter, diagnostic values etc. on display	--	✓	<input type="checkbox"/>	<input type="checkbox"/>	<input type="checkbox"/>	<input type="checkbox"/>	<input type="checkbox"/>	<input type="checkbox"/>	<input type="checkbox"/>	<input type="checkbox"/>
Indication of measured values (U, I, P, S, Q, p.f., etc.), parameters, diagnostic values etc. in release	--	✓	<input type="checkbox"/>	<input type="checkbox"/>	✓	<input type="checkbox"/>	<input type="checkbox"/>	<input type="checkbox"/>	<input type="checkbox"/>	<input type="checkbox"/>
Output of measured values (current only) to rotary coil instruments in control cabinet door	✓	✓	<input type="checkbox"/>	<input type="checkbox"/>	<input type="checkbox"/>	✓	<input type="checkbox"/>	<input type="checkbox"/>	<input type="checkbox"/>	<input type="checkbox"/>
Output of measured values (U, I, P, S, Q, p.f., etc.) to rotary coil instruments in control cabinet door	✓	✓	<input type="checkbox"/>	<input type="checkbox"/>	✓	✓	<input type="checkbox"/>	<input type="checkbox"/>	<input type="checkbox"/>	<input type="checkbox"/>
Output of digital signals (e. g. reason for tripping, alarm signals, status) through contacts	✓	✓	<input type="checkbox"/>	<input type="checkbox"/>	<input type="checkbox"/>	<input type="checkbox"/>	✓	<input type="checkbox"/>	<input type="checkbox"/>	<input type="checkbox"/>
Automatic changeover between parameter sets A and B	--	✓	<input type="checkbox"/>	<input type="checkbox"/>	<input type="checkbox"/>	<input type="checkbox"/>	<input type="checkbox"/>	✓	<input type="checkbox"/>	<input type="checkbox"/>
Read in digital signals and forward to PROFIBUS/MODBUS	✓	✓	<input type="checkbox"/>	✓	<input type="checkbox"/>	<input type="checkbox"/>	<input type="checkbox"/>	✓	<input type="checkbox"/>	<input type="checkbox"/>
Transmission of switch information on HTML basis locally to a PC	✓	✓	✓	<input type="checkbox"/>	<input type="checkbox"/>	<input type="checkbox"/>	<input type="checkbox"/>	<input type="checkbox"/>	<input type="checkbox"/>	✓
Transmission of switch information on HTML basis through Ethernet	✓	✓	✓	<input type="checkbox"/>	<input type="checkbox"/>	<input type="checkbox"/>	<input type="checkbox"/>	<input type="checkbox"/>	<input type="checkbox"/>	✓
Short-time grading control for S tripping and G protection	✓	✓	<input type="checkbox"/>	<input type="checkbox"/>	<input type="checkbox"/>	<input type="checkbox"/>	<input type="checkbox"/>	<input type="checkbox"/>	✓	<input type="checkbox"/>
Local display of harmonic analysis and waveform memory	--	✓	<input type="checkbox"/>	<input type="checkbox"/>	✓	<input type="checkbox"/>	<input type="checkbox"/>	<input type="checkbox"/>	<input type="checkbox"/>	<input type="checkbox"/>
Local storage of harmonic analysis and waveform memory and transmission through PROFIBUS	✓	✓	✓	✓	✓	<input type="checkbox"/>	<input type="checkbox"/>	<input type="checkbox"/>	<input type="checkbox"/>	<input type="checkbox"/>
Read out protection parameters through PROFIBUS	✓	✓	✓	✓	<input type="checkbox"/>	<input type="checkbox"/>	<input type="checkbox"/>	<input type="checkbox"/>	<input type="checkbox"/>	<input type="checkbox"/>
Read out and adjust protection parameters through PROFIBUS	--	✓	✓	✓	<input type="checkbox"/>	<input type="checkbox"/>	<input type="checkbox"/>	<input type="checkbox"/>	<input type="checkbox"/>	<input type="checkbox"/>

✓ Required

 Function can optionally be taken over by more than one release.

 Function can optionally be taken over by one of these modules.
 Not necessary for this function, optionally combinable

-- Function not available

3WL Air Circuit Breakers

3WL Air Circuit Breakers/Non-Automatic Air Circuit Breakers up to 6300 A (AC)

General data

Data that can be transmitted over the PROFIBUS DP/MODBUS or the Breaker Data Adapter

All 3WL circuit breakers with ETU45B, ETU76B (CubicleBUS integrated)



Transmittable circuit breaker data

	BSS F01 +"BDAPLUS"- Order No.	BDAPLUS	BSS F02/F12	COM15/COM16
Order code (Order No. of circuit breaker + "-Z")				
Order No.				

Potential applications

Transmission of circuit breaker data to PROFIBUS DP or MODBUS and integration into higher-level visualization systems are possible e. g. in PCS7, Power Management Systems, WinCC (including add-ons like the text message radio server)	--			✓
Transmission of circuit breaker data and software (i. e. HTML pages with data) to a local output device, or remotely through Ethernet/Intranet/Internet (without the possibility of integration into higher-level visualization systems) e. g. for monitoring, diagnostics, maintenance and parameterization of individual circuit breakers	✓		--	
Utilization of the functionality of all CubicleBUS modules e.g. configuration of the configurable digital output module, status check of the digital input modules, diagnostics	✓			✓

Transmittable circuit breaker data without integrated measurement function

Device identification Communication address, Order No., switch in as-delivered state, circuit breaker parameters (size, number of poles, rated current module etc.), identification numbers, release type, free text for plant code and comments	✓ --1)			✓ ✓
Operating states On/off status message, storage spring, tripped, readiness Switching position (connected, test and disconnected position, not present) for withdrawable circuit breakers, PROFIBUS/MODBUS write protection on/off, free user input	✓ --1) --1)			✓ ✓ ✓
Control commands Switch circuit breakers ON/OFF, switch free user output ON/OFF Reset tripped signal Delete event and history memory Rest min./max. measured values, reset maintenance information	--1) ✓ --1) ✓			✓ ✓ ✓ ✓
History Read out the event protocol, read out the release protocol	--1)			✓
Information on maintenance Number of tripping operations - L, S/I and total, contact erosion Number of switching operations - under load and total, operating hours	✓ --1)			✓ ✓
Event signals Tripped signals with data on tripping currents Alarmsignals (e. g. overload) with incoming/outgoing information All named event signals with time stamp	✓ --1) --1)			✓ ✓ ✓
Parameterization of protection functions Readout of protection function parameters Modification of settings for protection function parameters via communication Parameter set switchover supported (set A to set B and vice versa)	✓ ✓ ²⁾ ✓ ²⁾			✓ ✓ ²⁾ ✓ ²⁾
Measured values Phase currents, each with min./max. value Temperature in the circuit breaker with min./max. value Temperature in the control cabinet with min./max. value All named measured values with time stamp	✓ --1) --1) --1)			✓ ✓ ✓ ✓



Measurement function Plus

F05

Order code F01+ ... or F02+ ...

Additional transmittable circuit breaker data with integrated measurement function

Additional event signals Threshold value alarms (e. g. over/underfrequency, over/undervoltage)	✓			
Parameterization of expanded protection functions and setpoints (threshold values) Readout of parameters of expanded protection functions Modification of settings for protection function parameters Readout and setting of threshold values	✓ ✓ ✓			
Additional measured values Voltages, powers, energy, p.f., Frequency with min./max. value Harmonic analysis Recording of currents and voltages for configurable events in waveform memory	✓ ✓ ✓			

1) Data only available in conjunction with the COM15 module (BUS connection not required).

✓ Available
-- Not available

2) Only possible with ETU76B.

3WL Air Circuit Breakers/Non-Automatic Air Circuit Breakers up to 6300 A (AC)

General data

CubicleBUS modulesDigital output modules with rotary coding switch

6 items of binary information concerning the state of the circuit breaker (reasons for tripping and warnings) can be output via this module to external signaling devices (e. g. light, horn) or be used for the selective shut-down of other system components (e. g. frequency converters).

Digital output modules are available in versions with and without a rotary coding switch. On modules with a rotary coding switch it is possible to choose between two signaling blocks each with 6 defined assignments and to set an additional response delay.

All the digital output modules are available as a version with relay outputs (CO contacts, up to 12 A). Up to two modules of this type can be connected to one 3WL circuit breaker.



Digital output modules with rotary coding switch

Digital output modules, configurable

The configurable output module is available for higher-performance solutions. With this module, random events on the **CubicleBUS** can be switched directly to one of six available outputs or three of these outputs can be assigned with up to six events. In other words, up to six events can be placed on one physical output with "OR" operation. Either BDA/BDA *Plus* or Switch ES Power is used for configuring.

A relay variant is also available here the same as for the output modules with rotary coding switch. Only one module of this type is possible per 3WL circuit breaker.



Digital output modules, configurable

Analog output modules

The analog output module can be used to output the following measured values to analog indicators in the control cabinet door:

- $I_{L1}, I_{L2}, I_{L3}, I_N$ or
- $U_{L12}, U_{L23}, U_{L31}, U_{L1N}$ or
- $P_{L1}, P_{L2}, P_{L3}, S_{tot}$ or
- p.f. 1, p.f. 2, p.f. 3, ΔI % or
- $f_{avg}, U_{LLavg}, P_{tot}, p.f.-avg$

Four 4-20-mA/0-10-V interfaces are available for this. The measured values to be output are selected with a rotary coding switch. By using the analog output module it is possible to do without additional converters and their conventional installation/wiring in the main current path. Up to two modules of this type can be connected to one 3WL circuit breaker.



Analog output modules

Digital input module

With the digital input module, up to 6 additional binary signals (24 V DC) in the circuit breaker environment can be connected to the system. It is thus possible for example to send messages concerning the state of a switch disconnector or a control cabinet door to the PROFIBUS DP/MODBUS.

With the digital input module on the **CubicleBUS** it is also possible for the two different protection parameter sets held in the ETU76B electronic releases to be switched over automatically in a few milliseconds. It is thus possible, for example, to automatically change the parameters of a coupling switch should the transformer infeed fail.

One module each of this type can be used for holding the six items of digital information and for automatically switching over the parameters.



Digital input module

ZSI modules (short-time grading control)

The use of ZSI modules is recommended when Siemens circuit breakers are arranged in several staggered levels but full grading with the smallest possible delay is to be assured nevertheless.

The circuit breakers are interconnected by these modules. In case of a short-circuit, each affected circuit breaker asks the circuit breakers directly downstream whether the short-circuit has also occurred in the next, lower level. The short-circuit is exactly localized as the result, and only the next upstream circuit breaker in the energy flow direction is switched off.



ZSI modules (short-time grading control)

3WL Air Circuit Breakers

3WL Air Circuit Breakers/Non-Automatic Air Circuit Breakers up to 6300 A (AC)

General data

Technical specifications

Switching capacity

Sizes	I					II					III							
Type	3WL11					3WL12					3WL13							
Switching capacity class	N	N	S	S	H	H	N	N	S	S	H	H	H	H	C 3-pole	C	C 4-pole	C
Short-circuit breaking capacity																		
Rated operational voltage U_e up to 415 V AC																		
I_{cu}	kA	55	66	85	85	66	80	100	100	100	100	100	100	150	130			
I_{cs}	kA	55	66	85	85	66	80	100	100	100	100	100	100	150	130			
I_{cm}	kA	121	145	187	187	145	176	220	220	220	220	220	220	330	286			
Rated operational voltage U_e up to 500 V AC																		
I_{cu}	kA	55	66	85	85	66	80	100	100	100	100	100	100	150	130			
I_{cs}	kA	55	66	85	85	66	80	100	100	100	100	100	100	150	130			
I_{cm}	kA	121	145	187	187	145	176	220	220	220	220	220	220	330	286			
Rated operational voltage U_e up to 690 V AC																		
I_{cu}	kA	42	50	66	66	50	75	85	85	85	85	85	85	150	130			
I_{cs}	kA	42	50	66	66	50	75	85	85	85	85	85	85	150	130			
I_{cm}	kA	88	105	145	145	105	165	187	187	187	187	187	187	330	286			
Rated operational voltage U_e up to 1000 V/1150 V AC																		
I_{cu}	kA	--	--	50 ⁹⁾	50 ⁹⁾	--	--	50	50	50	50	50	50	70 ⁴⁾	70 ⁴⁾			
I_{cs}	kA	--	--	50 ⁹⁾	50 ⁹⁾	--	--	50	50	50	50	50	50	70 ⁴⁾	70 ⁴⁾			
I_{cm}	kA	--	--	105 ⁹⁾	105 ⁹⁾	--	--	105	105	105	105	105	105	154 ⁴⁾	154 ⁴⁾			
Rated short-time withstand current I_{cw} of the circuit breakers³⁾																		
0.5 s	kA	55	66	75	75	66	80	100	100	100	100	100	100	100	100	100	100	100
1 s	kA	42	50	66	66	55	66	80	80	80	80	80	80	100	100	100	100	100
2 s	kA	29.5	35	46	46	39	46	65 ^{1)/70²⁾}	65 ^{1)/70²⁾}	65 ^{1)/70²⁾}	65 ^{1)/70²⁾}	65 ^{1)/70²⁾}	65 ^{1)/70²⁾}	80	80	80	80	
3 s	kA	24	29	37	37	32	44	50 ^{1)/65²⁾}	50 ^{1)/65²⁾}	50 ^{1)/65²⁾}	50 ^{1)/65²⁾}	50 ^{1)/65²⁾}	50 ^{1)/65²⁾}	65	65	65	65	
Short-circuit breaking capacity I_{cc} of the non-automatic air circuit breakers																		
Up to 500 V AC	kA	55	66	75	75	66	80	100	100	100	100	100	100	100	100	100	100	100
Up to 690 V AC	kA	42	50	66	66	50	75	85	85	85	85	85	85	100	100	100	100	100
Up to 1000 V /1150 V AC	kA	--	--	50 ⁹⁾	50 ⁹⁾	--	--	50 ⁴⁾	50 ⁴⁾	50 ⁴⁾	50 ⁴⁾	50 ⁴⁾	50 ⁴⁾	70 ⁴⁾	70 ⁴⁾	70 ⁴⁾	70 ⁴⁾	70 ⁴⁾

Sizes	II				
Type	3WL12				
Switching capacity class	DC				
Short-circuit breaking capacity					
Up to 220 V DC I_{cc}	kA	35			
Up to 300 V DC I_{cc}	kA	30			
Up to 600 V DC I_{cc}	kA	25			
Up to 1000 V DC I_{cc}	kA	20			
Rated short-time withstand current I_{cw}					
0.5 s	kA	--			
1 s	kA	35 ^{5)/30^{6)/25^{7)/20⁸⁾}}}			
2 s	kA	--			
3 s	kA	--			

- (N)** Circuit breaker with ECO switching capacity N
- (S)** Circuit breaker with standard switching capacity S
- (H)** Circuit breaker with high switching capacity H
- (C)** Circuit breakers with very high switching capacity C
- (DC)** Non-automatic air circuit breakers with DC switching capacity

These switching capacities are indicated in the corresponding tables by the symbols shown on orange backgrounds.

Abbreviations (functions)

L	= Long Time Delay	= Overload protection
S	= Short Time Delay	= Short-circuit protection (short-time delayed)
I	= Instantaneous	= Short-circuit protection (instantaneous)
N	= Neutral Protection	Neutral conductor protection
G	= Ground Fault	Ground-fault protection

L, S, I, N, G: Designation according to IEC 60947-2, Appendix K.

1) Size II with $I_{n \max} \leq 2500$ A.

2) Size II with $I_{n \max} = 3200$ A and $I_{n \max} = 4000$ A.

3) At a rated voltage of ≥ 690 V the I_{cw} value of the circuit breaker cannot be greater than the I_{cu} or I_{cs} value at 690 V.

4) Rated operational voltage $U_e = 1150$ V.

5) At $U_e = 220$ V DC.

6) At $U_e = 300$ V DC.

7) At $U_e = 600$ V DC.

8) At $U_e = 1000$ V DC.

9) Values also apply to version 690 V + 20 % with Z option "A16".

3WL Air Circuit Breakers

3WL Air Circuit Breakers/Non-Automatic Air Circuit Breakers up to 6300 A (AC)

General data

Sizes	I				II				
Type	...	3WL11 10	3WL11 12	3WL11 16	3WL11 20	3WL12 08	3WL12 10	3WL12 12	3WL12 16
Rated current I_n at 40 °C, at 50/60 Hz									
Main conductors	A	... 1000	1250	1600	2000	800	1000	1250	1600
N conductor (only on 4-pole versions)	A	... 1000	1250	1600	2000	800	1000	1250	1600
Rated operational voltage U_e at 50/60 Hz (1000 V version, see Catalog LV 10.1, "Options")	V AC
		690/1000	690/1000	690/1000	690/1000	690/1000	690/1000	690/1000	690/1000
Rated insulation voltage U_i	V AC	1000	1000	1000	1000	1000	1000	1000	1000
Rated impulse withstand voltage U_{imp}									
• Main current paths	kV	12	12	12	12	12	12	12	12
• Auxiliary circuits	kV	4	4	4	4	4	4	4	4
• Control circuits	kV	2.5	2.5	2.5	2.5	2.5	2.5	2.5	2.5
Isolating function to EN 60 947-2		Yes	Yes	Yes	Yes	Yes	Yes	Yes	Yes
Utilization category		B							
Permissible ambient temperature									
• During operation (in operation with LCD max. 55 °C) ⁴⁾	°C	-25/+70	-25/+70	-25/+70	-25/+70	-25/+70	-25/+70	-25/+70	-25/+70
• During storage (special conditions for LCDs must be observed)	°C	-40/+70	-40/+70	-40/+70	-40/+70	-40/+70	-40/+70	-40/+70	-40/+70
Permissible load									
At rear horizontal main connections	A	1000	1250	1600	2000	800	1000	1250	1600
• Up to 55 °C (Cu bare)	A	1000	1250	1600	1930	800	1000	1250	1600
• Up to 60 °C (Cu bare) ⁵⁾	A	1000	1210	1490 ⁸⁾	1780	800	1000	1250	1600
• Up to 70 °C (Cu black painted) ⁵⁾	A	1000	1210	1490 ⁸⁾	1780	800	1000	1250	1600
Rated rotor operational voltage U_{er}	V	2000	2000	2000	2000	2000	2000	2000	2000
Power loss at I_n with 3-phase symmetrical load									
• Fixed-mounted circuit breakers	W	100	105	150	240	40	45	80	85
• Withdrawable circuit breakers	W	195	205	350	440	85	95	165	175
Switching times									
• Make-time	ms	35	35	35	35	35	35	35	35
• Opening time	ms	38	38	38	38	34	34	34	34
• Electrical make-time (through closing solenoid) ²⁾	ms	80	80	80	80	100	100	100	100
• Electrical opening time (through shunt release)	ms	73	73	73	73	73	73	73	73
• Electrical opening time (instantaneous undervoltage release)	ms	73	73	73	73	73	73	73	73
• Opening time due to ETU, instantaneous short-circuit release	ms	50 ¹⁾	50 ¹⁾	50 ¹⁾	50 ¹⁾	50 ¹⁾	50 ¹⁾	50 ¹⁾	50 ¹⁾
Endurance: Switching capacity N and S, 3/4-pole									
• Mechanical (without maintenance)	Operating cycles	10 000	10 000	10 000	10 000	10 000	10 000	10 000	10 000
• Mechanical (with maintenance) ³⁾	Operating cycles	20 000	20 000	20 000	15 000	15 000	15 000	15 000	15 000
• Electrical (without maintenance)	Operating cycles	10 000	10 000	10 000	7 500	7 500	7 500	7 500	7 500
• 1000 V version, electrical (without maintenance)	Operating cycles	--	--	--	1 000	1 000	1 000	1 000	1 000
• 1150 V version, electrical (without maintenance)	Operating cycles	--	--	--	--	500	500	500	500
• Electrical (with maintenance) ³⁾	Operating cycles	20 000	20 000	20 000	15 000	15 000	15 000	15 000	15 000
Endurance: Switching capacity H, 3-pole									
• Mechanical (without maintenance)	Operating cycles	10 000	10 000	10 000	10 000	10 000	10 000	10 000	10 000
• Mechanical (with maintenance) ³⁾	Operating cycles	15 000	15 000	15 000	15 000	15 000	15 000	15 000	15 000
• Electrical (without maintenance)	Operating cycles	7 500	7 500	7 500	7 500	7 500	7 500	7 500	7 500
• 1000 V version, electrical (without maintenance)	Operating cycles	1 000	1 000	1 000	1 000	1 000	1 000	1 000	1 000
• 1150 V version, electrical (without maintenance)	Operating cycles	--	--	--	--	500	500	500	500
• Electrical (with maintenance) ³⁾⁹⁾	Operating cycles	15 000	15 000	15 000	15 000	15 000	15 000	15 000	15 000
Endurance: Switching capacity H, 4-pole									
• Mechanical (without maintenance)	Operating cycles	10 000	10 000	10 000	10 000	10 000	10 000	10 000	10 000
• Mechanical (with maintenance) ³⁾	Operating cycles	15 000	15 000	15 000	15 000	15 000	15 000	15 000	15 000
• Electrical (without maintenance)	Operating cycles	7 500	7 500	7 500	7 500	7 500	7 500	7 500	7 500
• 1000 V version, electrical (without maintenance)	Operating cycles	1 000	1 000	1 000	1 000	1 000	1 000	1 000	1 000
• 1150 V version, electrical (without maintenance)	Operating cycles	--	--	--	--	500	500	500	500
• Electrical (with maintenance) ³⁾⁹⁾	Operating cycles	10 000	10 000	10 000	10 000	15 000	15 000	15 000	15 000
Switching frequency⁶⁾									
• 690 V version	1/h	60 ⁷⁾	60 ⁷⁾	60 ⁷⁾	60	60 ⁷⁾	60 ⁷⁾	60 ⁷⁾	60 ⁷⁾
• 1000 V version	1/h	--	--	--	20	20	20	20	20
• 1150 V version	1/h	--	--	--	--	20	20	20	20
Minimum interval between tripping operation by electronic release and next making operation of the circuit breaker (only with autom. mechanical resetting of the lockout device).	ms	80	80	80	80	80	80	80	80
Minimum interval between ON/OFF or OFF/ON switching operations.									

1) Opening time on instantaneous short-circuit release with ETU15B = 85 ms.

2) Make-time through closing solenoid for synchronization purposes (short-time excited) 50 ms.

3) Maintenance means: replace main contact elements and arc chutes (see Operating Manual).

4) Use of releases from -20 °C

5) ETU76B with graphics display can be used up to max. 55 °C.

6) Minimum interval between 2 switching operations.

7) 3-pole switching with switching capacity N and S: 45/h.

8) For switching capacity H: 1600 A to 70 °C.

9) The main contacts of size I circuit breakers with switching capacity H can only be replaced at the factory.

3WL Air Circuit Breakers

3WL Air Circuit Breakers/Non-Automatic Air Circuit Breakers up to 6300 A (AC)

General data

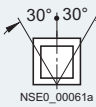
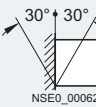
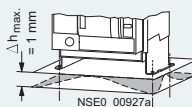
Sizes	I				II						
Type	... 3WL11 10 3WL11 12 3WL11 16 3WL11 20 3WL12 08 3WL12 10 3WL12 12 3WL12 16										
Mounting position					and/or						
Degree of protection	IP20 without cabinet door, IP41 with door sealing frame, IP55 with cover										
Main conductor minimum cross-sections	<ul style="list-style-type: none"> Copper bars, bare 	Unit(s)	1 x	2 x	2 x	3 x	1 x	1 x	2 x	2 x	
		mm ²	60 x 10	40 x 10	50 x 10	50 x 10	50 x 10	60 x 10	60 x 10	50 x 10	
	<ul style="list-style-type: none"> Copper bars, painted black 	Unit(s)	1 x	2 x	2 x	3 x	1 x	1 x	2 x	2 x	
		mm ²	60 x 10	40 x 10	50 x 10	50 x 10	50 x 10	60 x 10	40 x 10	50 x 10	
Auxiliary conductors (Cu)	Standard connection = strain-relief clamp										
Max. number of auxiliary conductors x cross-section (solid/stranded)	<ul style="list-style-type: none"> Without end sleeve With end sleeve according to DIN 46228 Part 2 With twin end sleeve 		2 x 0.5 mm ² (AWG 20) ... 2 x 1.5 mm ² (AWG 16); 1 x 2.5 mm ² (AWG 14)								
	Optional connection = tension spring		1 x 0.5 mm ² (AWG 20) ... 1 x 1.5 mm ² (AWG 16)								
	<ul style="list-style-type: none"> Without end sleeve With end sleeve according to DIN 46228 Part 2 		2 x 0.5 mm ² (AWG 20) ... 2 x 2.5 mm ² (AWG 14)								
			2 x 0.5 mm ² (AWG 20) ... 2 x 1.5 mm ² (AWG 16)								
Position signaling switches	Tension spring terminals		1 x 0.5 mm ² (AWG 20) ... 1 x 2.5 mm ² (AWG 14)								
Weights	3-pole		kg	43	43	43	43	56	56	56	56
	<ul style="list-style-type: none"> Fixed-mounted CBs Withdrawable CBs Guide frames 	kg	45	45	45	45	60	60	60	60	60
	4-pole		kg	25	25	25	25	31	31	31	31
	<ul style="list-style-type: none"> Fixed-mounted CBs Withdrawable CBs Guide frames 	kg	50	50	50	50	67	67	67	67	67
		kg	54	54	54	54	72	72	72	72	72
		kg	30	30	30	30	37	37	37	37	37

3WL Air Circuit Breakers

3WL Air Circuit Breakers/Non-Automatic Air Circuit Breakers up to 6300 A (AC)

General data

Sizes	II				III			
Type	3WL12 20	3WL12 25	3WL12 32	3WL12 40	3WL13 40	3WL13 50	3WL13 63	
Rated current I_n at 40 °C, at 50/60 Hz								
Main conductors	A 2000	2500	3200	4000	4000	5000	6300	
N conductor (only on 4-pole versions)	A 2000	2500	3200	4000	4000	5000	6300	
Rated operational voltage U_o at 50/60 Hz (1000 V version, see Catalog LV 10.1, "Options")	V AC ... 690/1000 690	
Rated insulation voltage U_i	V AC 1000	1000	1000	1000	1000	1000	1000	
Rated impulse withstand voltage U_{imp}								
• Main current paths	kV 12	12	12	12	12	12	12	
• Auxiliary circuits	kV 4	4	4	4	4	4	4	
• Control circuits	kV 2.5	2.5	2.5	2.5	2.5	2.5	2.5	
Isolating function to EN 60947-2	Yes	Yes	Yes	Yes	Yes	Yes	Yes	
Utilization category	B (except switching capacity class DC)							
Permissible ambient temperature								
• During operation (in operation with LCD max. 55 °C) ⁴⁾	°C -25/+70	-25/+70	-25/+70	-25/+70	-25/+70	-25/+70	-25/+70	
• During storage (special conditions for LCDs must be observed)	°C -40/+70	-40/+70	-40/+70	-40/+70	-40/+70	-40/+70	-40/+70	
Permissible load⁶⁾								
• Up to 55 °C (Cu bare)	A 2000	2500	3200	3950	4000	5000	5920	
• Up to 60 °C (Cu bare) ⁵⁾	A 2000	2500	3020	3810	4000	5000	5810	
• Up to 70 °C (Cu black painted) ⁵⁾	A 2000	2280	2870	3600	4000	5000	5500	
Rated rotor operational voltage U_{er}	V 2000	2000	2000	2000	2000	2000	2000	
Power loss at I_n with 3-phase symmetrical load								
• Fixed-mounted circuit breakers	W 180	270	410	750	520	630	900	
• Withdrawable circuit breakers	W 320	520	710	925	810	1050	1600	
Switching times								
• Make-time	ms 35	35	35	35	35	35	35	
• Opening time	ms 34	34	34	34	34	34	34	
• Electrical make-time (through closing solenoid) ²⁾	ms 100	100	100	100	100	100	100	
• Electrical opening time (through shunt release)	ms 73	73	73	73	73	73	73	
• Electrical opening time (instantaneous undervoltage release)	ms 73	73	73	73	73	73	73	
• Opening time due to ETU, instantaneous short-circuit release	ms 50 ¹⁾	50 ¹⁾	50 ¹⁾	50 ¹⁾	50	50	50	
Endurance								
• Mechanical (without maintenance)	Operating cycles 10000	10000	10000	10000	5000	5000	5000	
• Mechanical (with maintenance) ³⁾	Operating cycles 15000	15000	15000	15000	10000	10000	10000	
• Electrical (without maintenance) up to 690 V	Operating cycles 7500	7500	4000	2000	2000	2000	2000	
• 1000 V version, electrical (without maintenance)	Operating cycles 1000	1000	1000	1000	1000	1000	1000	
• 1150 V version, electrical ⁷⁾ (without maintenance)	Operating cycles 500	500	500	500	500	500	500	
• Switching capacity C: Electrical (without maintenance) up to 690 V	Operating cycles --	--	--	--	1000	1000	1000	
• Switching capacity C: Electrical (without maintenance) up to 1150 V	Operating cycles --	--	--	--	500	500	500	
• Electrical (with maintenance) ³⁾	Operating cycles 15000	15000	15000	15000	10000	10000	10000	
Switching frequency⁸⁾								
• 690 V version	1/h 60 ⁹⁾	60 ⁹⁾	60 ⁹⁾	60 ⁹⁾	60	60	60	
• 1000 V version	1/h 20	20	20	20	20	20	20	
• 1150 V version ⁷⁾	1/h 20	20	20	20	20	20	20	
Minimum interval between tripping operation by electronic release and next making operation of the circuit breaker (only with automatic mechanical resetting of the lockout device)	ms 80	80	80	80	80	80	80	
Minimum interval between ON/OFF or OFF/ON switching operations.								

- 1) Opening time on instantaneous short-circuit release with ETU15B = 85 ms.
- 2) Make-time through closing solenoid for synchronization purposes (short-time excited) 50 ms.
- 3) Maintenance means: replace main contact elements and arc chutes (see Operating Manual).
- 4) Use of releases from -20 °C

- 5) ETU76B with graphics display can be used up to max. 55 °C.
- 6) 4000 A, size II in fixed-mounted version, 3-pole.
- 7) Size II with order code "A15" and size III: Data for very high switching capacity.
- 8) Minimum interval between 2 switching operations.
- 9) 3-pole switching with switching capacity N and S: 45/h.

3WL Air Circuit Breakers

3WL Air Circuit Breakers/Non-Automatic Air Circuit Breakers up to 6300 A (AC)

General data

Sizes	II				III				
Type	3WL12 20	3WL12 25	3WL12 32	3WL12 40	3WL13 40	3WL13 50	3WL13 63		
Mounting position									
Degree of protection	IP20 without cabinet door, IP41 with door sealing frame, IP55 with cover								
Main conductor minimum cross-sections	<ul style="list-style-type: none"> Copper bars, bare 	Unit(s) mm ²	3 x 50 x 10	2 x 100 x 10	3 x 100 x 10	4 x 120 x 10	4 x 100 x 10	6 x 100 x 10	6 x 120 x 10
	<ul style="list-style-type: none"> Copper bars, painted black 	Unit(s) mm ²	3 x 50 x 10	2 x 100 x 10	3 x 100 x 10	4 x 100 x 10 ¹⁾	4 x 100 x 10	6 x 100 x 10	6 x 120 x 10
Auxiliary conductors (Cu)	Standard connection = strain-relief clamp		2 x 0.5 mm ² (AWG 20) ... 2 x 1.5 mm ² (AWG 16); 1 x 2.5 mm ² (AWG 14)						
Max. no. of auxiliary conductors x cross-section (solid/stranded)	<ul style="list-style-type: none"> Without end sleeve With end sleeve according to DIN 46228 Part 2 With twin end sleeve 		1 x 0.5 mm ² (AWG 20) ... 1 x 1.5 mm ² (AWG 16)						
	Optional connection = tension spring		2 x 0.5 mm ² (AWG 20) ... 2 x 1.5 mm ² (AWG 16)						
	<ul style="list-style-type: none"> Without end sleeve With end sleeve according to DIN 46228 Part 2 		2 x 0.5 mm ² (AWG 20) ... 2 x 2.5 mm ² (AWG 14) 2 x 0.5 mm ² (AWG 20) ... 2 x 1.5 mm ² (AWG 16)						
Position signaling switches	Tension spring terminals		1 x 0.5 mm ² (AWG 20) ... 1 x 2.5 mm ² (AWG 14)						
Weights									
3-pole	<ul style="list-style-type: none"> Fixed-mounted circuit breakers Withdrawable circuit breakers Guide frames 	kg	56 60 31	59 63 39	64 68 45	85 121 52	82 88 60	82 88 60	90 96 70
4-pole	<ul style="list-style-type: none"> Fixed-mounted circuit breakers Withdrawable circuit breakers Guide frames 	kg	67 72 37	71 76 47	77 82 54	103 146 62	99 106 84	99 106 84	108 108 119

¹⁾ Minimum main conductor cross-sections for 4-pole withdrawable circuit breakers: 4 x 120 x 10 mm

3WL Air Circuit Breakers

3WL Air Circuit Breakers/Non-Automatic Air Circuit Breakers up to 6300 A (AC)

General data

Sizes	I to III		
Type	3WL1		
Manual operating mechanism with mechanical closing			
Closing/ Charging stored-energy feature	Max. force required to operate the hand lever Required number of strokes on the hand lever	N	≤ 230 9
Manual operating mechanism with mechanical and electrical closing			
Charging stored-energy feature			
Closing solenoid (CC)	<ul style="list-style-type: none"> Primary operating range 		0.85 ... 1.1 × U _s
	<ul style="list-style-type: none"> Extended operating range for battery operation 	At 24 V DC, 48 V DC 60 V DC, 110 V DC 220 V DC	0.7 ... 1.26 × U _s
	<ul style="list-style-type: none"> Rated control supply voltage U_s 	50/60 Hz AC DC	V 110 ... 127; 208 ... 240 V 24; 30; 48; 60; 110 ... 125; 220 ... 250
	<ul style="list-style-type: none"> Power consumption 	AC/DC	VA/W 15/15
	<ul style="list-style-type: none"> Minimum command duration at U_s for the closing solenoid 		ms 60
	<ul style="list-style-type: none"> Short-circuit protection Smallest permissible DIAZED fuse (gL operational class)/ miniature circuit breaker with C characteristic 		1 A TDz (slow)/1 A
Manual/motorized operating mechanism with mechanical and electrical closing			
Manual operating mechanism			For data see above.
Motor	<ul style="list-style-type: none"> Primary operating range Extended operating range for battery operation 		0.85 ... 1.1 × U _s 0.7 ... 1.26 × U _s
	<ul style="list-style-type: none"> Power consumption of motor 	AC/DC	VA/W 135/135
	<ul style="list-style-type: none"> Time required to charge the stored-energy mechanism at 1 × U_s 		s ≤ 10
Closing solenoid			For data see above.
For motor and closing solenoid	<ul style="list-style-type: none"> Short-circuit protection Smallest permissible DIAZED fuse (gL operational class)/miniature circuit breaker with C characteristic; Motor and closing solenoid for identical rated control supply voltages 		6 A TDz (slow)/2 A
	<ul style="list-style-type: none"> Smallest permissible DIAZED fuse (gL operational class)/ miniature circuit breaker with C characteristic (for different rated control supply voltages) 	At U _s = 24 ... 30 V At U _s = 48 ... 60 V At U _s = 110 ... 125 V DC/ 110 ... 127 V AC At U _s = 220 ... 250 V DC/ 208 ... 240 V AC	6 A 6 A 2 A 2 A
Electronic release signals			
Measuring accuracy of the electronic release			Protection functions acc. to EN 60947; current indication ≤ 10 %; Measurement function Base electrical quantities ≤ 1 %; Measurement function derived variables ≤ 4 %
Auxiliary releases			
Undervoltage releases UVR (F3) and UVR-t_d (F4)	<ul style="list-style-type: none"> Response values 	Pick-up Dropout	≥ 0.85 × U _s (circuit breaker can be closed) 0.35 ... 0.7 × U _s (circuit breaker is tripped)
	<ul style="list-style-type: none"> Primary operating range 		0.85 ... 1.1
	<ul style="list-style-type: none"> Extended operating range for battery operation 	At 24 V DC, 30 V DC, 48 V DC, 110 V DC, 220 V DC	0.85 ... 1.26
	<ul style="list-style-type: none"> Rated control supply voltage U_s 	Instantaneous 50/60 Hz AC DC	V 110 ... 127/208 ... 240/380 ... 415 V 24/30/48/60/110 ... 125/220 ... 250 ¹⁾
		Delayed 50/60 Hz AC DC	V 110 ... 127; 208 ... 240; 380 ... 415 V 48; 110 ... 125; 220 ... 250
	<ul style="list-style-type: none"> Power consumption (pickup/uninterrupted duty) 	AC DC	VA 20/5 W 20/5
	<ul style="list-style-type: none"> Opening time of circuit breaker at U_s = 0 		ms 200
	<ul style="list-style-type: none"> - Version UVR (F3) 		
	<ul style="list-style-type: none"> Instantaneous 		ms 80
	<ul style="list-style-type: none"> With delay 		ms 200
	<ul style="list-style-type: none"> - Version UVR-t_d (F8) 		
	<ul style="list-style-type: none"> with delay, t_d = 0.2 to 3.2 s 		s 0.2 ... 3.2
	<ul style="list-style-type: none"> Reset via additional NC contact – direct switching off 		ms ≤ 100
	<ul style="list-style-type: none"> Short-circuit protection Smallest permissible DIAZED fuse (gL operational class)/ miniature circuit breaker with C characteristic 		1 A TDz (slow)/1 A

¹⁾ 24 V and 30 V only with undervoltage release UVR (F3).

3WL Air Circuit Breakers

3WL Air Circuit Breakers/Non-Automatic Air Circuit Breakers up to 6300 A (AC)

General data

Sizes	I to III						
Type	3WL1						
Auxiliary releases							
Shunt release (ST) (F1, F2)	<ul style="list-style-type: none"> For continuous command (100 % ON period), locks out on momentary-contact commands 	- Response value	Pick-up	> 0.7 × U _s (circuit breaker is tripped)			
		- Primary operating range		0.85 ... 1.1 × U _s			
		- Extended operating range for battery operation	At 24 V DC, 48 V DC 60 V DC, 110 V DC 220 V DC		0.7 ... 1.26 × U _s		
		- Rated control supply voltage U _s	50/60 Hz AC DC	V	110 ... 127; 208 ... 240 24; 30; 48; 60; 110 ... 125; 220 ... 250		
		- Power consumption	AC/DC	VA/W	15/15		
		- Minimum command duration at U _s		ms	60		
		- Opening time of circuit breaker at U _s = 100 %	AC/DC	ms	80		
		- Short-circuit protection Smallest permissible DIAZED fuse (gL operational class)/miniature circuit breaker with C characteristic			1 A TDz (slow)/1 A		
		5 % OP		- Response value	Pick-up	> 0.7 × U _s (circuit breaker is tripped)	
				- Primary operating range		0.85 ... 1.1 × U _s	
				- Extended operating range for battery operation	At 24 V DC, 48 V DC 60 V DC, 110 V DC 220 V DC		0.7 ... 1.26 × U _s
				- Rated control supply voltage U _s	50/60 Hz AC DC	V	110 ... 127; 208 ... 240 24; 48; 110 ... 125; 220 ... 250
				- Power consumption	AC/DC	VA/W	15/15
- Minimum command duration at U _s				ms	25		
- Opening time of circuit breaker at U _s = 100 %	AC/DC			ms	50		
- Short-circuit protection Smallest permissible DIAZED fuse (gL operational class)/miniature circuit breaker with C characteristic					1 A TDz (slow)/1 A		
With stored energy feature consisting of shunt release and capacitor storage device				- Rated control supply voltage U _s	50/60 Hz AC DC	V 110; 230 V 110; 220	
				- Primary operating range		0.85 ... 1.1 × U _s	
				- Power consumption	AC/DC	VA/W	1/1
				- Storage time at U _s /recharging time at U _s			max. 5 min/min. 5 s
				- Opening time of circuit breaker, short-circuit protection			As with "for continuous command"
Remote reset solenoid for mechanical tripped indicator (F7)							
Remote reset solenoid for mechanical tripped indicator (F7)		- Primary operating range		0.85 ... 1.1 × U _s			
		- Extended operating range for battery operation	At 24 V DC, 48 V DC 110 V DC 220 V DC		0.7 ... 1.26 × U _s		
		- Power consumption	AC/DC	VA/W	50/50		
		- Minimum command duration at U _s for the remote reset solenoid		ms	60		
		- Short-circuit protection Smallest permissible DIAZED fuse (gL operational class)/miniature circuit breaker with C characteristic			2 A TDz (slow)/1 A at 24 V DC and 48 V DC, 1 A TDz (slow)/1 A at 110 V and 208 ... 250 V		
Contact position-driven auxiliary switches (S1, S2, S3, S4, S7, S8)							
Rated insulation voltage U_i		V AC/DC	500				
Rated operational voltage U_e		V AC/DC	500				
Rated impulse withstand voltage U_{imp}		kV	4				
Switching capacity	<ul style="list-style-type: none"> Alternating current 50/60 Hz Direct current 	- Rated operational voltage U _e	V	24 ... 230	380/400	500	
		- rated operational current I _e /AC-12	A	10	10	10	
		- rated operational current I _e /AC-15	A	4	3	2	
		- Rated operational voltage U _e	V	24	48	110	220
		- rated operational current I _e /DC-12	A	10	8	3.5	1
		- rated operational current I _e /DC-13	A	8	4	1.2	0.4
Short-circuit protection	<ul style="list-style-type: none"> Largest permissible DIAZED fuse (gL operational class) Largest permissible miniature circuit breaker with C characteristic 		10 A TDz, 10 A Dz 10 A				

3WL Air Circuit Breakers

3WL Air Circuit Breakers/Non-Automatic Air Circuit Breakers up to 6300 A (AC)

General data

Sizes	I to III			
Type	3WL1			
Ready-to-close signaling switch (S20) (according to DIN VDE 0630)				
Switching capacity	• Alternating current	- Rated operational voltage U_e	V	250
		- Rated operational current I_e	A	8
• Direct current	- Rated operational voltage U_e	V	125	250
	- Rated operational current I_e	A	0.4	0.2
Short-circuit protection	Largest permissible DIAZED fuse (gL operational class)			2 A Dz (quick)
Tripped signaling switch (S24) and signaling switch for auxiliary releases (S22, S23) (according to DIN VDE 0630)				
Switching capacity	• Alternating current	- Rated operational voltage U_e	V	250
		- Rated operational current $I_e/AC-12$	A	8
• Direct current	- Rated operational voltage U_e	V	24	125
	- Rated operational current $I_e/DC-12$	A	6	0.4 0.2
Short-circuit protection	Largest permissible DIAZED fuse (gL operational class)			6 A Dz (quick)
Tripped signaling switch	Signal duration after tripping			Until manual or electrical remote reset (option)
Position signaling switch on guide frame				
Type of contact	• Signal:	- "Circuit breaker in connected position"	3 CO	1 CO
		- "Circuit breaker in test position"	2 CO	1 CO
		- "Circuit breaker in disconnected position"	1 CO	1 CO
			or	
Rated insulation voltage U_i	50/60 Hz AC	V	440	
	DC	V	250	
Rated operational voltage U_e		V	250	
Rated impulse withstand voltage U_{imp}		kV	4	
Switching capacity	• Rated operational current I_e	- $I_e/AC-12$	24 V 10 A, 110/127 V 10 A, 220/240 V 10 A, 320/440 V 10 A	
		- $I_e/AC-15$	220/240 V 4 A, 320/440 V 3 A,	
		- $I_e/DC-12$	24 V 10 A, 48 V 2.5 A, 220/240 V 0.2 A,	
		- $I_e/DC-13$	24 V 3.0 A, 220/240 V 0.1 A	
		- A 300 (AC)	120 V 6 A, 240 V 3 A	
		- R 300 (DC)	125 V 0.22 A, 250 V 0.11 A	
Short-circuit protection	• Largest permissible DIAZED fuse (gL operational class)			8 A TDz (slow)
	• Largest permissible miniature circuit breaker with C characteristic			8 A TDz (slow)

3WL Air Circuit Breakers

3WL Air Circuit Breakers/Non-Automatic Air Circuit Breakers up to 6300 A (AC)

General data

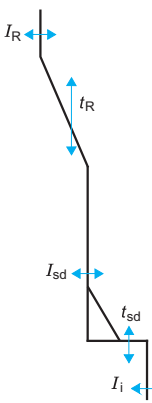
Protection functions Parameterization by	ETU15B D	ETU25B D	ETU27B D & S	
Functional overview of the electronic release system				
 <p>L Overload protection Function can be switched on/off Setting range $I_R = I_n \times \dots$</p> <p>N Neutral conductor protection Function can be switched on/off N conductor setting range $I_N = I_n \times \dots$</p> <p>S Short-time delayed short-circuit protection Function can be switched on/off Setting range $I_{sd} = I_n \times \dots$ Setting range for delay time t_{sd} Switchable short-time delayed short-circuit protection (I^2t-dependent function) Setting range for delay time t_{sd} at I^2t Zone Selective Interlocking function</p> <p>I Instantaneous short-circuit protection Function can be switched on/off Setting range $I_i = I_n \times \dots$</p> <p>G Ground-fault protection Tripping and alarm function Tripping function can be switched on/off Alarm function can be switched on/off Detection of the ground-fault current through summation current formation with internal or external N-conductor transformer Detection of ground-fault current through external current transformer Setting range of the operating current I_g for tripping Setting range of the operating current I_g for alarm Setting range of the delay time t_g Switchable ground-fault protection characteristic curve (I^2t-dependent function) Setting range for delay time t_g at I^2t Zone Selective Interlocking ground-fault protect. function</p>	✓	✓	✓	
	Function can be switched on/off	--	--	--
	Setting range $I_R = I_n \times \dots$	0.5-0.55-0.6-0.65-0.7-0.75-0.8-0.85-0.9-1	0.4-0.45-0.5-0.55-0.6-0.65-0.7-0.8-0.9-1	0.4-0.45-0.5-0.55-0.6-0.65-0.7-0.8-0.9-1
	Switchable overload protection (I^2t - or I^1t -dependent function)	--	--	--
	Setting range for time-lag class t_R at I^2t	10 s fixed	10 s fixed	10 s fixed
	Setting range for time-lag class t_R at I^1t	--	--	--
	Thermal image can be switched on/off	--	--	--
	Phase failure sensitivity	--	At $t_{sd} = 20$ ms (M)	At $t_{sd} = 20$ ms (M)
	Function can be switched on/off	--	--	✓
	N conductor setting range $I_N = I_n \times \dots$	--	--	1
Function can be switched on/off	--	✓	✓	
Setting range $I_{sd} = I_n \times \dots$	--	1.25-1.5-2-2.5-3-4-6-8-10-12	1.25-1.5-2-2.5-3-4-6-8-10-12	
Setting range for delay time t_{sd}	--	0-M-100-200-300-400 ms	0-M-100-200-300-400 ms	
Switchable short-time delayed short-circuit protection (I^2t -dependent function)	--	--	--	
Setting range for delay time t_{sd} at I^2t	--	--	--	
Zone Selective Interlocking function	--	--	--	
Function can be switched on/off	✓	✓	✓	
Setting range $I_i = I_n \times \dots$	2-3-4-5-6-7-8	Fixed for $I_i \geq 20 \times I_n$, max. 50 kA	Fixed for $I_i \geq 20 \times I_n$, max. 50 kA	
Tripping and alarm function	--	--	✓ Fixed mounted	
Tripping function can be switched on/off	--	--	✓	
Alarm function can be switched on/off	--	--	--	
Detection of the ground-fault current through summation current formation with internal or external N-conductor transformer	--	--	✓	
Detection of ground-fault current through external current transformer	--	--	--	
Setting range of the operating current I_g for tripping	--	--	A-B-C-D-E	
Setting range of the operating current I_g for alarm	--	--	--	
Setting range of the delay time t_g	--	--	100-200-300-400-500 ms	
Switchable ground-fault protection characteristic curve (I^2t -dependent function)	--	--	--	
Setting range for delay time t_g at I^2t	--	--	--	
Zone Selective Interlocking ground-fault protect. function	--	--	--	
Parameter set switchover				
Switchable between parameter set A and B	--	--	--	
LCD				
Alphanumeric LCD (4-line)	--	--	--	
Graphical LCD (24 V, external power supply required)	--	--	--	
Communication				
CubicleBUS integrated	--	--	--	
Communication-capable through PROFIBUS DP	--	--	--	
Measurement function				
Measurement-function capable with measurement function <i>Plus</i>	--	--	--	
LED display				
Electronic release active	✓	✓	✓	
Alarm	✓	✓	✓	
ETU fault	✓	✓	✓	
L-release	--	✓	✓	
S-release	--	✓	✓	
I-release	--	✓	✓	
N-release	--	✓	✓	
G-release	--	--	✓	
G-alarm	--	--	--	
Release through extended protection function	--	--	--	
Communication	--	--	--	
Signals from signaling switches with external CubicleBUS modules (relays)				
Overload warning	--	--	--	
Load shedding, load receiving	--	--	--	
Leading signal overload trip 200 ms	--	--	--	
Temperature alarm	--	--	--	
Phase unbalance	--	--	--	
Instantaneous short-circuit release	--	--	--	
Short-time delayed short-circuit release	--	--	--	
Overload trip	--	--	--	
Neutral conductor release	--	--	--	
Ground-fault protection release	--	--	--	
Ground-fault alarm	--	--	--	
Auxiliary relay	--	--	--	
ETU fault	--	--	--	

Delay time figures given in ms.
M = Motor protection, corresponds to 20 ms.
D = Rotary coding switch

D & S = Rotary coding and slide switch
K = communication
M/K = menu/communication

✓ Available.
-- Not available.
□ Optional.

For the setting range of the operating current I_g , see page 33.

3WL Air Circuit Breakers

3WL Air Circuit Breakers/Non-Automatic Air Circuit Breakers up to 6300 A (AC)

General data

Protection functions Parameterization by	ETU45B D & S	ETU76B M/K
Functional overview of the electronic release system		
Overload protection	✓	✓
Function can be switched on/off	--	✓
Setting range $I_R = I_n \times \dots$	0.4-0.45-0.5-0.55-0.6- 0.65-0.7-0.8-0.9-1	0.4 ... 1
Switchable overload protection (I^2t - or I^4t -dependent function)	✓	✓
Setting range for time-lag class t_R at I^2t	2-3.5-5.5-8-10-14-17-21-25-30 s	2 ... 30 s
Setting range for time-lag class t_R at I^4t	1-2-3-4-5 s	1 ... 5 s
Thermal image can be switched on/off	✓	✓
Phase failure sensitivity	At $t_{sd} = 20$ ms (M)	✓ (on/off)
Neutral conductor protection	✓	✓
Function can be switched on/off	✓	✓
N conductor setting range $I_N = I_n \times \dots$	0.5 ... 1	0.2 ... 2
Short-time delayed short-circuit protection	✓	✓
Function can be switched on/off	✓	✓
Setting range $I_{sd} = I_n \times \dots$	1.25-1.5-2-2.5-3-4-6-8-10-12	$1.25 \times I_n \dots 0.8 \times I_{cw}$
Setting range for delay time t_{sd}	M-100-200-300-400 ms	M-80 ... 4000 ms
Switchable short-time delayed short-circuit protection (I^2t -dependent function)	✓	✓
Setting range for delay time t_{sd} at I^2t	100-200-300-400 ms	100 ... 400 ms
Zone Selective Interlocking function	By Cubicle BUS-Module	By Cubicle BUS-Module
Instantaneous short-circuit protection	✓	✓
Function can be switched on/off	✓	✓
Setting range $I_I = I_n \times \dots$	1.5-2.2-3-4-6-8-10-12-0.8 $\times I_{cs}$	$1.5 \times I_n \dots 0.8 \times I_{cs}$
Ground-fault protection	<input type="checkbox"/> Module can be retrofitted	<input type="checkbox"/> Module can be retrofitted
Tripping and alarm function	✓	✓
Tripping function can be switched on/off	✓	✓
Alarm function can be switched on/off	--	✓
Detection of the ground-fault current through summation current formation with internal or external N conductor transformer	✓	✓
Detection of ground-fault current through external current transformer	✓	✓
Setting range of the operating current I_g for tripping	A-B-C-D-E	A ... E
Setting range of the operating current I_a for alarm	A-B-C-D-E	A ... E
Setting range of the delay time t_g	100-200-300-400-500 ms	100 ... 500 ms
Switchable ground-fault protection characteristic curve (I^2t -dependent function)	✓	✓
Setting range for delay time t_g at I^2t	100-200-300-400-500 ms	100 ... 500 ms
Zone Selective Interlocking ground-fault protect. function	By Cubicle BUS-Module	By Cubicle BUS-Module
Parameter set switchover		
Switchable between parameter set A and B	--	✓
LCD		
Alphanumeric LCD (4-line)	<input type="checkbox"/>	--
Graphical LCD (24 V, external power supply required)	--	✓
Communication		
Cubicle BUS integrated	✓	✓
Communication-capable through PROFIBUS DP	✓	✓
Measurement function		
Measurement-function capable with measurement function <i>Plus</i>	✓	✓
LED display		
Electronic release active	✓	✓
Alarm	✓	✓
ETU fault	✓	✓
L-release	✓	✓
S-release	✓	✓
I-release	✓	✓
N-release	✓	✓
G-release	✓ (only with ground-fault protection module)	✓ (only with ground-fault protection module)
G-alarm	✓ (only with ground-fault protection module)	✓ (only with ground-fault protection module)
Release through extended protection functions	✓	✓
Communication	✓	✓
Signals from signaling switches with external Cubicle BUS modules (relays)		
Overload warning	✓	✓
Load shedding, load receiving	✓	✓
Leading signal overload trip 200 ms	✓	✓
Temperature alarm	✓	✓
Phase unbalance	✓	✓
Instantaneous short-circuit release	✓	✓
Short-time delayed short-circuit release	✓	✓
Overload trip	✓	✓
Neutral conductor release	✓	✓
Ground-fault protection release	✓ (only with ground-fault protection module)	✓ (only with ground-fault protection module)
Ground-fault alarm	✓ (only with ground-fault protection module)	✓ (only with ground-fault protection module)
Auxiliary relay	✓	✓
ETU fault	✓	✓

Setting range of the operating current I_g	Size I and size II		Size III
	Size I	Size II	Size III
A	100 A	300 A	400 A
B	300 A	600 A	600 A
C	600 A	900 A	800 A
D	900 A	1200 A	1000 A
E	1200 A	1500 A	1200 A

Increment size for settings for ETU76B via menu			
From ... to	Increment size	From ... to	Increment size
0 ... 1	0.1	1000 ... 1600	50
1 ... 100	1	1600 ... 10000	100
100 ... 500	5	10000 ... max	1000
500 ... 1000	10		

For legend see page 32.

3WL Air Circuit Breakers

3WL Air Circuit Breakers/Non-Automatic Air Circuit Breakers up to 6300 A (AC)

Project planning aids

Characteristic curves²⁾

Every release type and every setting has its own characteristic curve. Only a selection is shown in the following. The characteristic curves each show the largest and smallest setting range of 3WL circuit breakers with 1000 A rated current at 500 V rated voltage with various releases. In order to obtain a complete tripping characteristic, the relevant parts of the characteristics have to be combined. The characteristic curves show the behavior of the release when it is activated by a current that is already flowing before the tripping operation. If the overcurrent tripping occurs immediately after switch on and the release is therefore not yet enabled, the opening time is extended, depending on the level of the overcurrent by up to 15 ms. In order to determine the break-times of the circuit breakers, approximately 15 ms must be added to the opening times shown for the arcing time.

Refer to the following legend for tolerances.

The characteristic curves shown apply to ambient temperatures at the circuit breaker between -5 and +55 °C. The release can be operated at ambient temperatures of -20 to +70°C. An extended tolerance band can apply at these temperatures.

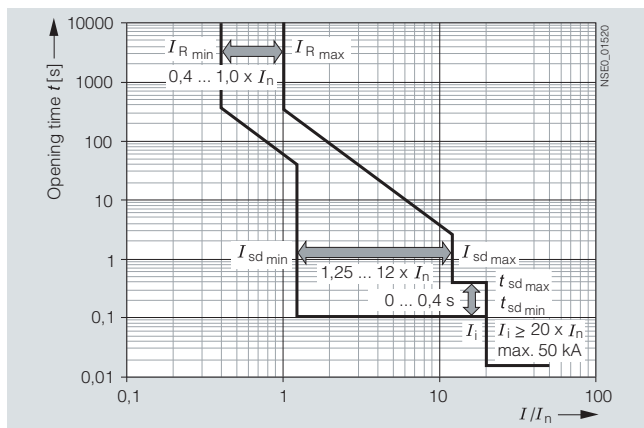

3WL circuit breaker with ETU25B release, LSI characteristic curve

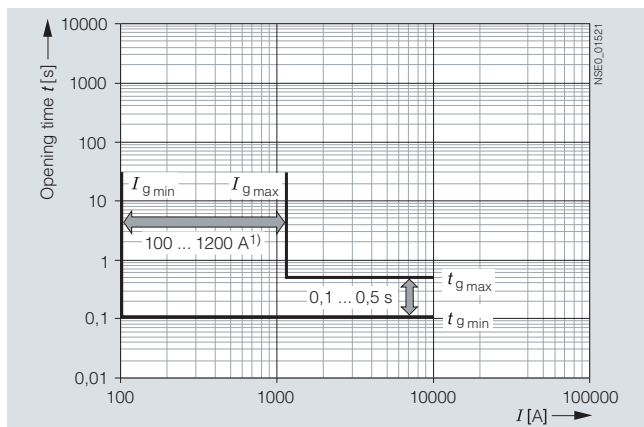

3WL circuit breaker with ETU27B release, G characteristic curve

Tolerances for the set currents

L: Tripping operations between 1.05 and 1.2 x I_R

S: -0 %, +20 %

I: -0 %, +20 %

G: -0 %, +20 %

Tolerances for the tripping times

L: -20 %, +0 % for I²t characteristic curve

S: -0 %, +60 ms or -0 %, 10 % for tripping times greater than 600 ms

I: <50 ms

G: -0 %, +60 ms or -0 %, 10 % for tripping times greater than 600 ms

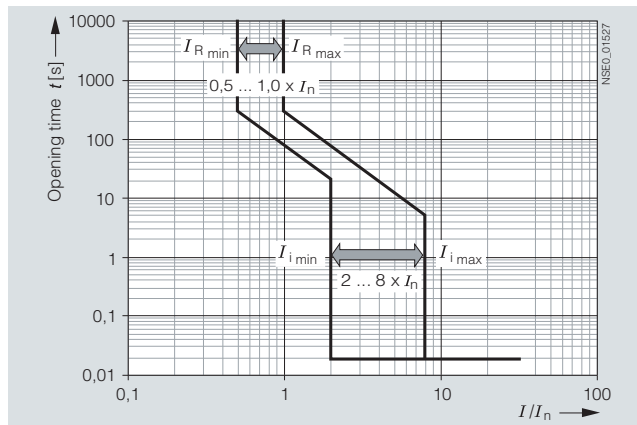

3WL circuit breaker with ETU15B release

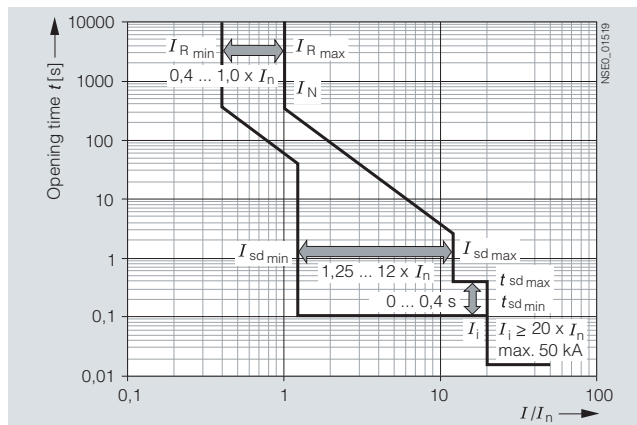

3WL circuit breaker with ETU27B release, LSIN characteristic curve

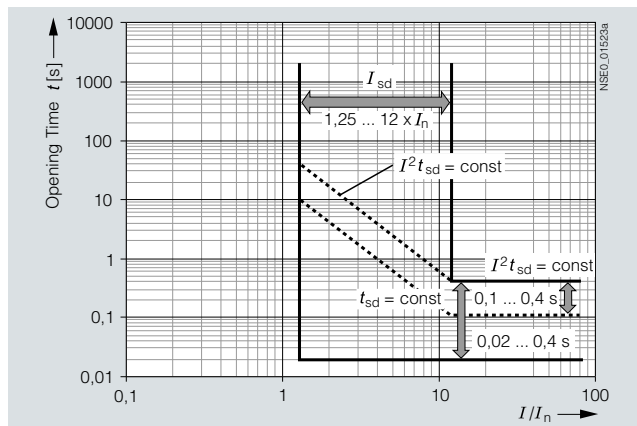

3WL circuit breaker with ETU45B release, S characteristic curve

- 1) Sizes I and II: 100 ... 1200 A
Size III: 400 ... 1200 A.

- 2) With single-pole loading in the lowest rated current range, the response times of the short-circuit release can be extended by approx. 10 % and the tripping times by approx. 15% compared to the characteristic curve.

3WL Air Circuit Breakers/Non-Automatic Air Circuit Breakers up to 6300 A (AC)

Project planning aids

Every release type and every setting has its own characteristic curve. Only a selection is shown in the following. The characteristic curves each show the largest and smallest setting range of 3WL circuit breakers with 1000 A rated current at 500 V rated voltage with various releases.

In order to obtain a complete tripping characteristic, the relevant parts of the characteristics have to be combined.

The characteristic curves show the behavior of the release when it is activated by a current that is already flowing before the tripping operation. If the overcurrent tripping occurs immediately after switch on and the release is therefore not yet enabled, the opening time is extended, depending on the level of the overcurrent by up to 15 ms. In order to determine the total break-times of the circuit breakers, approximately 15 ms must be added to the opening times shown for the arcing time.

Refer to the following table for tolerances.

The characteristic curves shown apply to ambient temperatures at the circuit breaker between -5 and +55 °C. The release can be operated at ambient temperatures of -20 to +70°C (ETU76B with graphics display up to +55 °C). An extended tolerance band can apply at these temperatures.

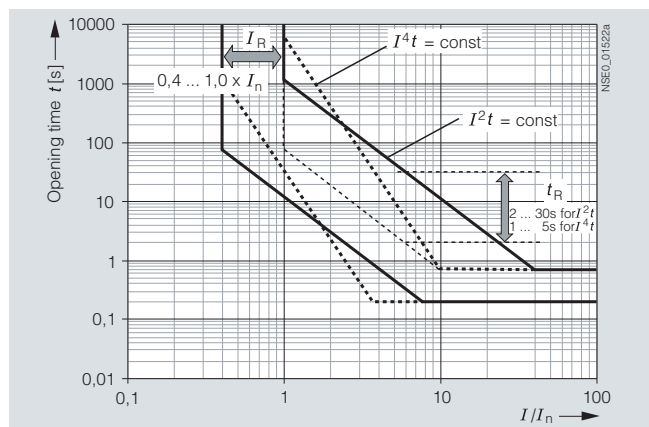

3WL circuit breaker with ETU45B and ETU76B release, L characteristic curve

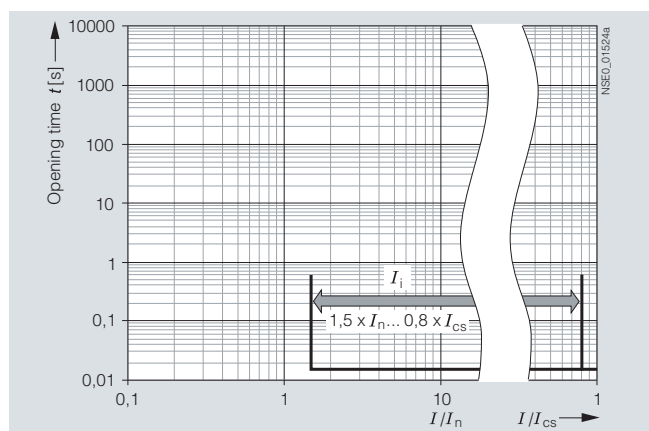

3WL circuit breaker with ETU45B and ETU76B release, I characteristic curve

1) Sizes I and II: 100 ... 1200 A
Size III: 400 ... 1200 A.

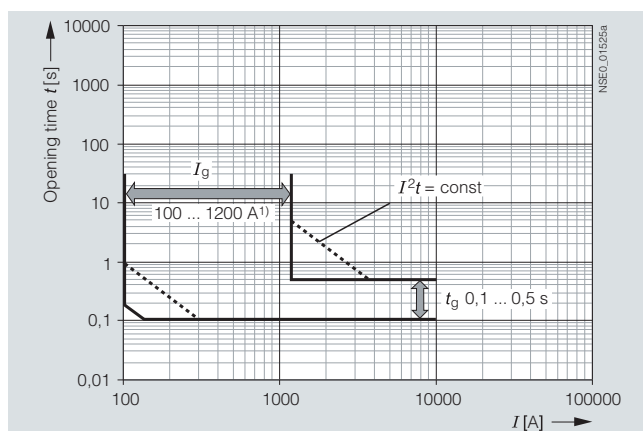

3WL circuit breaker with ETU45B and ETU76B release, G characteristic curve

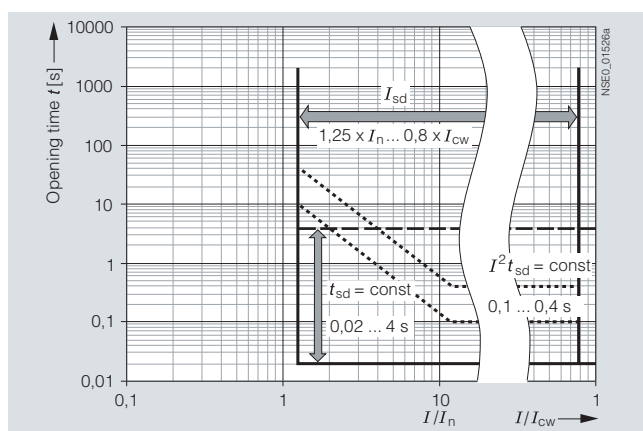

3WL circuit breaker with ETU76B release, S characteristic curve

Further characteristic curves are shown in the manual and the planning and configuring tool SIMARIS deSign, or ask your Siemens contact person.

Tolerances for the set currents

L: Tripping operations between 1.05 and 1.2 × IR

S: -0 %, +20 %

I: -0 %, +20 %

G: -0 %, +20 %

Tolerances for the tripping times

L: -20 %, +0 % for I²t characteristic curve

S: -0 %, +60 ms or -0 %, 10 % for tripping times greater than 600 ms

I: <50 ms

G: -0 %, +60 ms or -0 %, 10 % for tripping times greater than 600 ms

3WL Air Circuit Breakers

3WL Air Circuit Breakers/Non-Automatic Air Circuit Breakers up to 6300 A (AC)

Project planning aids

Dimensional drawings

Voltage transformer for 3WL air circuit breakers

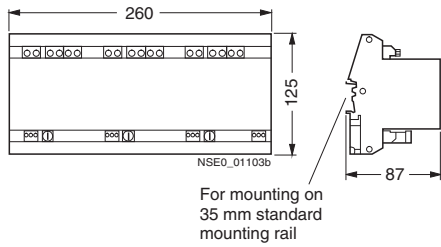

Current transformers for overload protection in the N conductor

External current transformers for N conductor with copper connection pieces

Size I, 3WL9 111-0AA31-0AA0

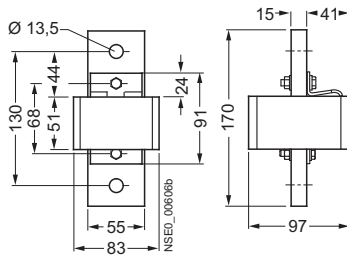

Size II, 3WL9 111-0AA32-0AA0

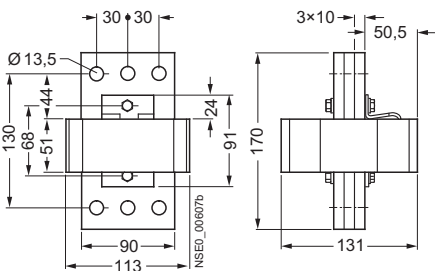

Size III, 3WL9 111-0AA33-0AA0

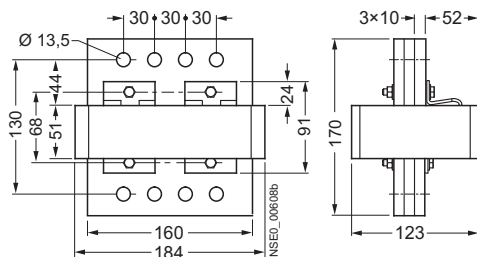

External current transformers for N conductor without copper connection pieces

Size I, 3WL9 111-0AA21-0AA0

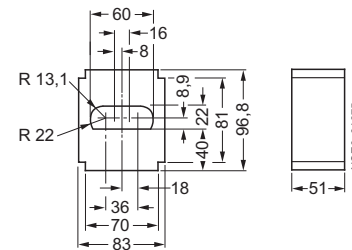

Size II, 3WL9 111-0AA22-0AA0

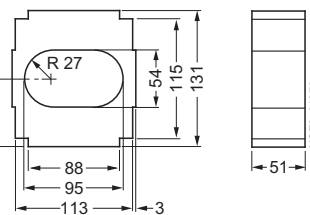

Size III, 3WL9 111-0AA23-0AA0

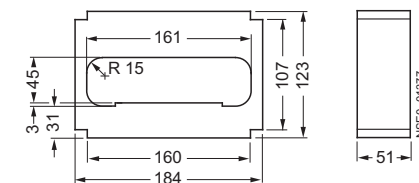

Door cutout for operator panel

Door cutout with edge protector

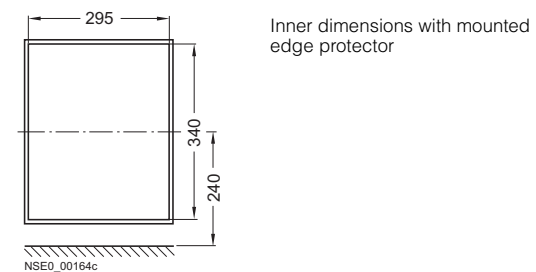

Door cutout for operator panel using the door sealing frame

Option with/without door interlocking

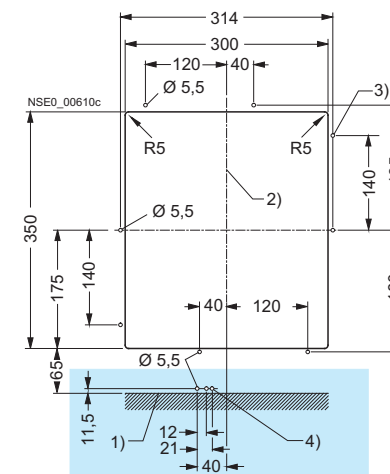

■ Dimensions for option with door interlocking

- 1) Mounting surface
- 2) Center 3WL circuit breaker operator panel
- 3) 8 mounting holes for door sealing frame
- 4) 3 mounting holes for door interlocking

3WL Air Circuit Breakers

3WL Air Circuit Breakers/Non-Automatic Air Circuit Breakers up to 6300 A (AC)

Project planning aids

CubicleBUS modules

3WL9 111-0AT2-0AA0

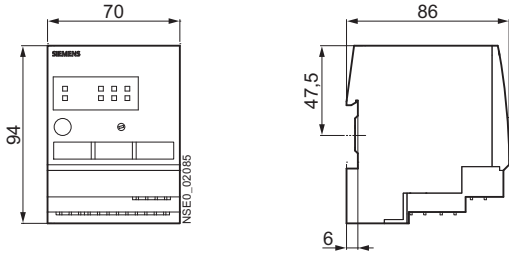

Breaker Data Adapter (BDA)

3WL9 111-0AT28-0AA0

3WL9 111-0AT33-0AA0

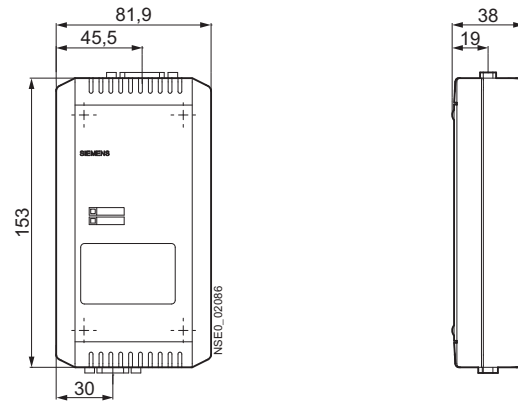

3WL Air Circuit Breakers

3WL Air Circuit Breakers/Non-Automatic Air Circuit Breakers up to 6300 A (AC)

Project planning aids

Door cutout for operator panel using protective cover IP55

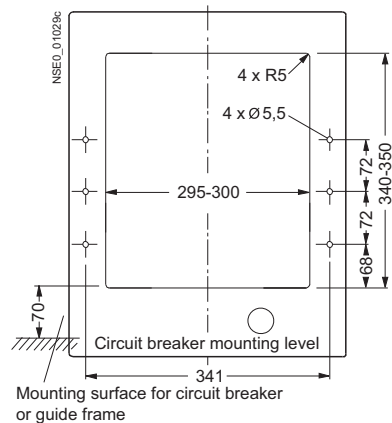

Protective cover, IP55

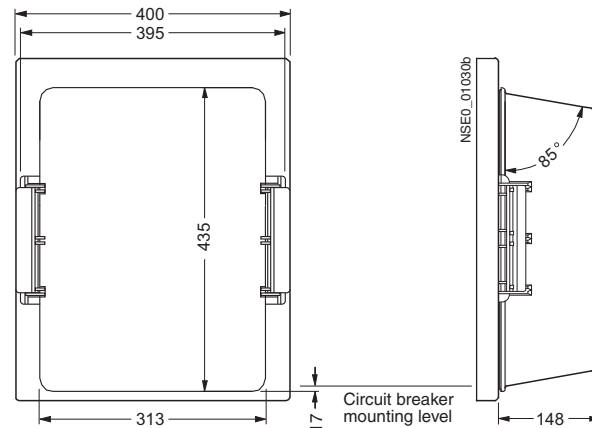

Safety clearance from grounded parts

Rated operational voltage V/AC	Above auxiliary connector mm	Lateral (each side) mm	Rear mm
Size I, fixed-mounted version			
500	75 ¹⁾	0	0
690	75 ¹⁾	0	0
Size I, withdrawable version, without arc chute cover			
500	50 ¹⁾	0	0
690	50 ¹⁾	0	0
Size I, withdrawable version, with arc chute cover			
500	0	0 ²⁾	0
690	0	0 ²⁾	0
Size II, fixed-mounted version			
500	75 ¹⁾	0	0
690	75 ¹⁾	0	0
1000	180	0	0
Size II, withdrawable version, without arc chute cover			
500	50 ¹⁾	0	0
690	50 ¹⁾	0	0
1000	100	0	0
Size II, withdrawable version, with arc chute cover			
500	0	0 ²⁾	0
690	0	0 ²⁾	0
Size III, fixed-mounted version			
500	75 ¹⁾	0	0
690	75 ¹⁾	0	0
1000	180	0	0
Size III, withdrawable version, without arc chute cover			
500	50 ¹⁾	0	0
690	50 ¹⁾	0	0
1000	100	0	0
Size III, withdrawable version, with arc chute cover			
500	0	0 ²⁾	0
690	0	0 ²⁾	0
DC non-automatic air circuit breakers			
300	45	0	0
600	200	0	0
1000	150	0	0

All safety clearances above the circuit breaker refer to the upper edge of the auxiliary connector - not to the upper edge of the arc chute! See dimensional drawings on pages 39 to 47, Parts 4) and 5).

Safety clearances from live parts

Rated operational voltage V/AC	Above auxiliary connector mm	Lateral (each side) mm	Rear mm
Size I, fixed-mounted version			
500	150	20	20
690	300	50	125
1000	500 ³⁾	100 ³⁾	140 ³⁾
Size I, fixed-mounted version, with arc chute cover			
500	14	50 ⁴⁾	14
690	14	225 ⁴⁾	14
Size I, withdrawable version, without arc chute cover			
500	150	20	14
690	300	50	14
1000	500 ³⁾	100 ³⁾	140 ³⁾
Size I, withdrawable version, with arc chute cover			
500	14	100	14
690	14	100	14
Size II, fixed-mounted version			
500	250	50	20
690	600	100	140
1000	430	100	125
Size II, withdrawable version, without arc chute cover			
500	250	50	14
690	600	100	30
1000	350	100	14
Size II, withdrawable version, with arc chute cover			
500	14	50	14
690	14	225	14
Size III, fixed-mounted version			
500	75	20	20
690	500	100	125
1000	430	100	125
Size III, withdrawable version, without arc chute cover			
500	50	20	14
690	500	100	14
1000	350	100	14
Size III, withdrawable version, with arc chute cover			
500	14	50	14
690	14	200	14

1) Value for plate; 0 mm for struts and grids

2) 40 mm (size II: 70 mm) for plates, which cover the lateral openings in the guide frame

3) Not for switching capacity S.

4) For switching capacity S: 100 mm.

3WL Air Circuit Breakers

3WL Air Circuit Breakers/Non-Automatic Air Circuit Breakers up to 6300 A (AC)

Project planning aids

Size I, up to 2000 A, fixed-mounted version, 3 and 4-pole

Standard version
Horizontal connection

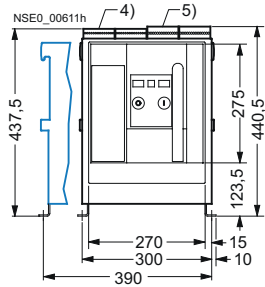

Optional connection variants Front connection (single), not suitable for circuit breakers with rated current 2000 A

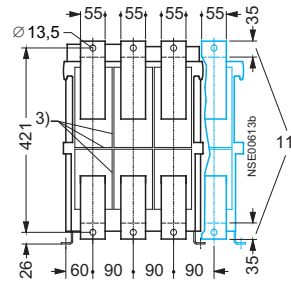
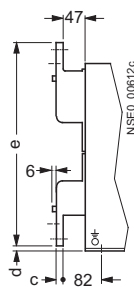

Front connection (double hole) according to DIN 43673

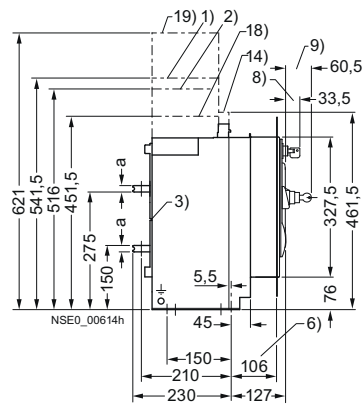
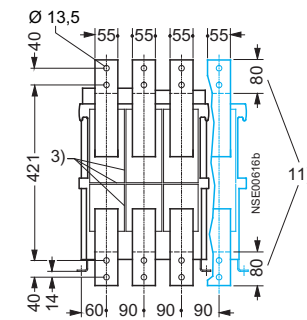
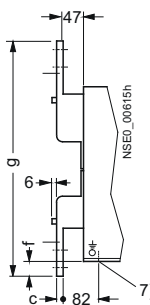

Vertical connection

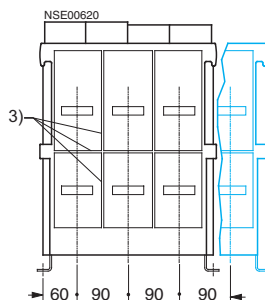
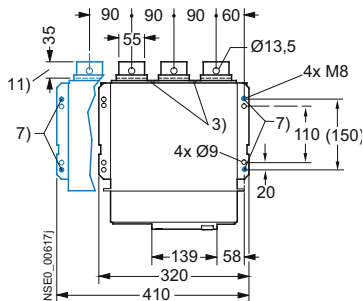
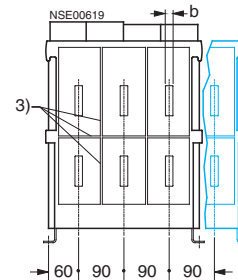
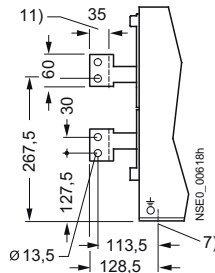

Rated circuit breaker current	a	b	c	d	e	f	g
A							
Up to 1000	10	10	10	11	451	34	541
1250 ... 2000	15	20	15	6	461	39	551

4-pole version

- 1) Mounting space for removal of the arc chutes.
- 2) Arc quenching space ≤ 690 V – circuit breaker facing grounded or non-conductive surfaces.
- 3) Rivets (4 mm wide, 5 mm deep) for supporting phase barriers in the system.
- 4) Auxiliary connector with SIGUT screw terminals.
- 5) Auxiliary connector with screwless connection method.
- 6) Dimension to inside surface of the closed cabinet door.
- 7) Fixing points for mounting the circuit breaker in the system; 4 × setting nut M8.
- 8) "Secure OFF" locking device (optional accessory).

- 9) Key operation (optional accessory).
- 11) Terminal face.
- 14) Space for electrical auxiliary circuit connections.
- 18) Circuit breaker upper edge, only 690 V (+20 %) and 1000 V circuit breakers.
- 19) Arc quenching space, circuit breaker facing grounded or non-conductive surfaces, only 690 V (+20 %) and 1000 V circuit breakers.

For safety clearances to grounded parts and to live parts see page 38.

3WL Air Circuit Breakers

3WL Air Circuit Breakers/Non-Automatic Air Circuit Breakers up to 6300 A (AC)

Project planning aids

Size I, up to 2000 A, withdrawable version, 3 and 4-pole

Standard version Horizontal connection

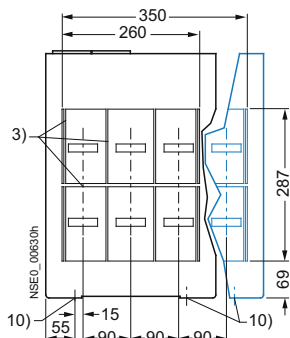
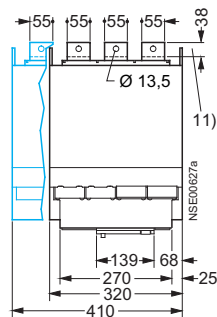
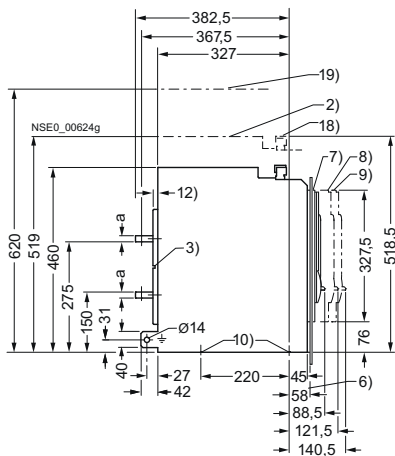
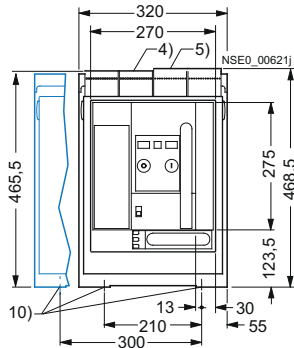

Optional connection variants Front connection (single), not suitable for circuit breakers with rated current 2000 A

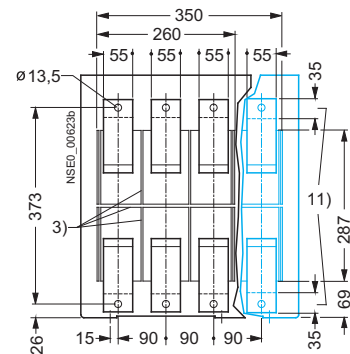
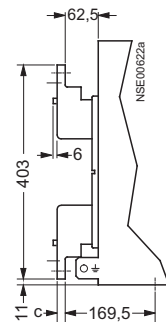

Front connection (double hole) according to DIN 43673

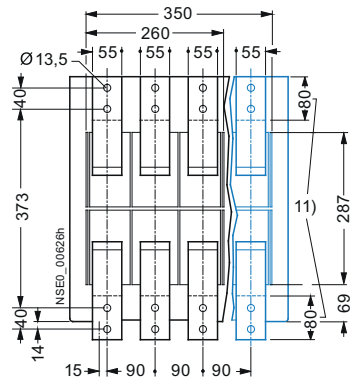
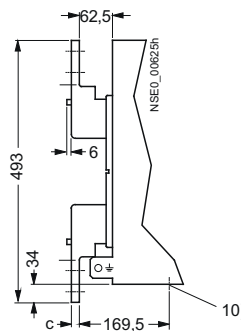

Vertical connection

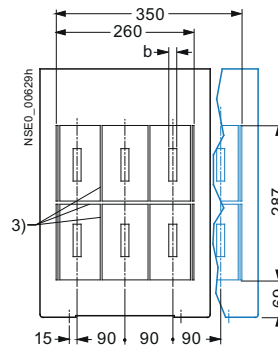
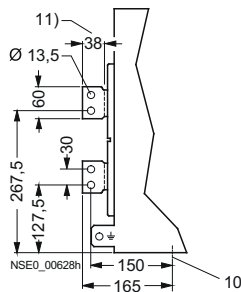

4-pole version

- 2) For guide frame without arc chute cover, arc quenching space ≤ 690 V – circuit breaker facing grounded or non-conductive surfaces.
- 3) Rivets (4 mm wide, 5 mm deep) for supporting phase barriers in the system.
- 4) Auxiliary connector with SIGUT screw terminals.
- 5) Auxiliary connector with screwless connection method.
- 6) Dimension to inside surface of the closed cabinet door.
- 7) Circuit breaker in connected position.
- 8) Circuit breaker in test position.
- 9) Circuit breaker in disconnected position.
- 10) Fixing holes 10 mm.
- 11) Terminal face.
- 18) Circuit breaker upper edge, only 690 V (+20 %) and 1000 V circuit breakers.
- 19) Arc quenching space, circuit breaker facing grounded or non-conductive surfaces, only 690 V (+20 %) and 1000 V circuit breakers.

Rated circuit breaker current A	a	b	c
Up to 1000	10	10	10
1250 ... 2000	15	15	15

For safety clearances to grounded parts and to live parts see page 38.

Flange connections (see following page)

3WL Air Circuit Breakers

3WL Air Circuit Breakers/Non-Automatic Air Circuit Breakers up to 6300 A (AC)

Project planning aids

Size II, up to 4000 A, fixed-mounted version, 3 and 4-pole

Standard version
Horizontal connection

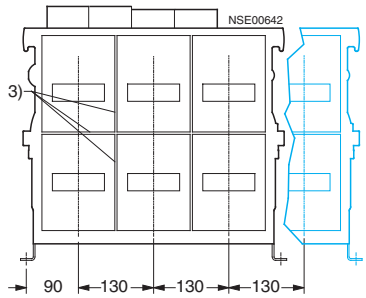
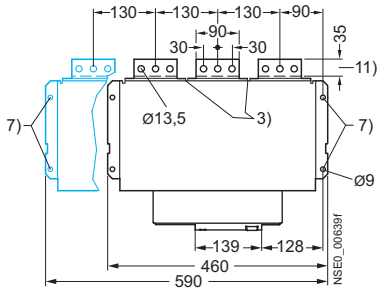
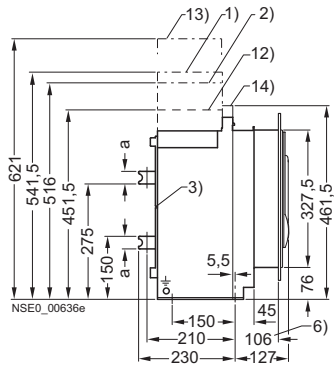
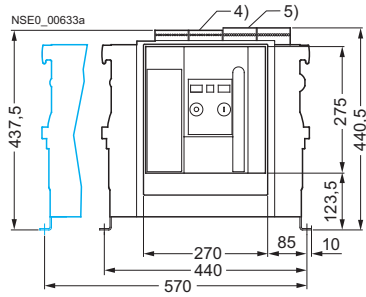

Optional connection variants
Front connection (single)

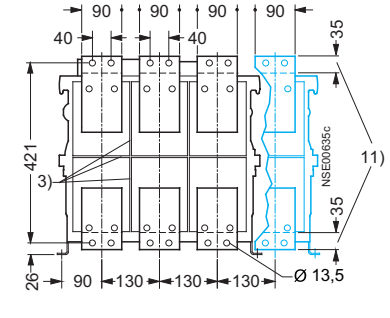
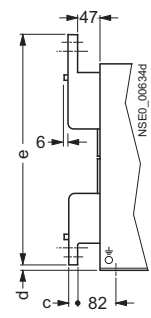

Front connection (double hole)
according to DIN 43673

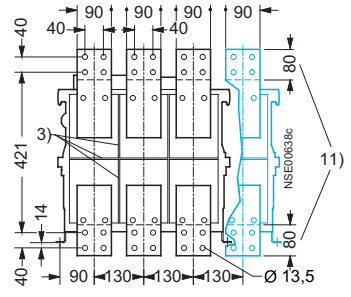
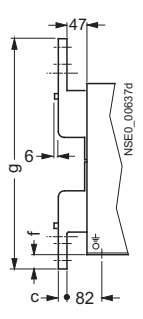

Vertical connection up to 3200 A

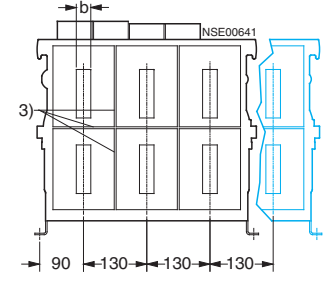
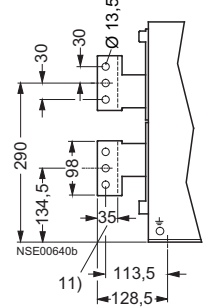

— 4-pole version

- 1) Mounting space for removal of the arc chutes.
- 2) Arc quenching space "≤ 690 V" – circuit breaker facing grounded or non-conductive surfaces.
- 3) Rivets (4 mm wide, 5 mm deep) for supporting phase barriers in the system.
- 4) Auxiliary connector with SIGUT screw terminals.
- 5) Auxiliary connector with spring-loaded connection.
- 6) Dimension to inside surface of the closed cabinet door.
- 7) Fixing points for mounting the circuit breaker in the system.
- 11) Terminal face.
- 12) Circuit breaker upper edge, only 1000 V and 1150 V circuit breaker.
- 13) Arc quenching space, 1000 V and 1150 V circuit breaker facing grounded or non-conductive surfaces.
- 14) Space for electrical auxiliary circuit connections.

Rated circuit breaker current	a	b	c	d	e	f	g
Up to 2000	10	15	10	11	451	34	541
2500	15	15	20	6	461	39	551
3200	30	30	20	6	461	39	551

For safety clearances to grounded parts and to live parts see page 38.
Flange connections (see following page)

3WL Air Circuit Breakers

3WL Air Circuit Breakers/Non-Automatic Air Circuit Breakers up to 6300 A (AC)

Project planning aids

Size II, up to 4000 A, fixed-mounted version, 3 and 4-pole

Vertical connection 4000 A

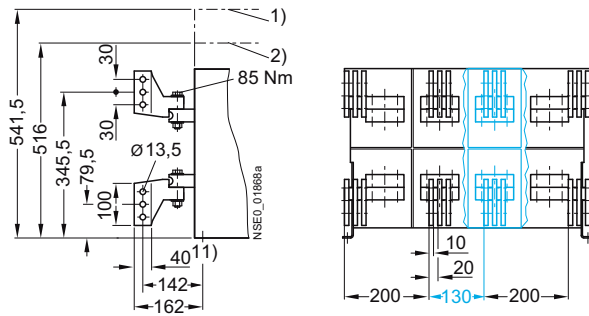

- 1) Mounting space for removal of the arc chutes.
- 2) Arc quenching space " ≤ 690 V" – circuit breaker facing grounded or non-conductive surfaces.
- 11) Terminal face.

For safety clearances to grounded parts and to live parts see page 38.

For more connection options see previous page.

3WL Air Circuit Breakers

3WL Air Circuit Breakers/Non-Automatic Air Circuit Breakers up to 6300 A (AC)

Project planning aids

Size II, up to 3200 A, withdrawable version, 3 and 4-pole

Standard version
Horizontal connection

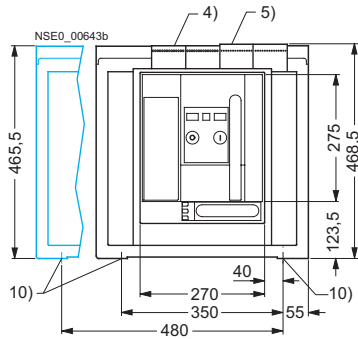

Optional connection variants
Front connection (single)

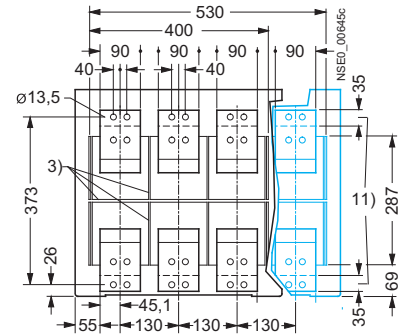
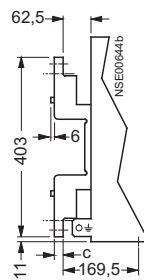

Front connection (double hole)
according to DIN 43673

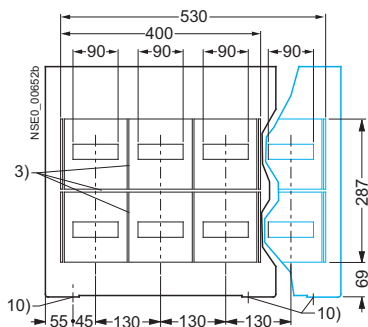
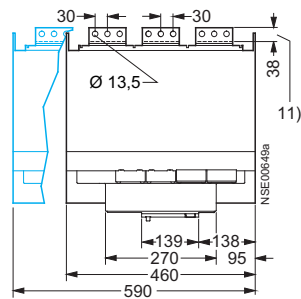
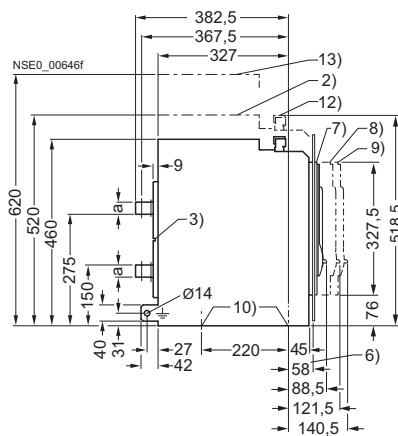
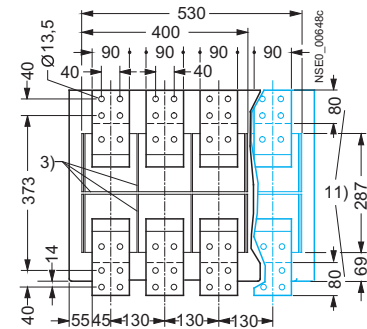
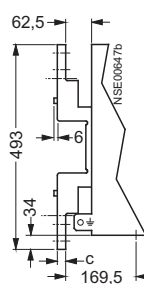

4-pole version

- 2) For guide frame ≤ 690 V, without arc chute cover, arc quenching space facing grounded or non-conductive surfaces.
- 3) Rivets (4 mm wide, 5 mm deep) for supporting phase barriers in the system.
- 4) Auxiliary connector with SIGUT screw terminals.
- 5) Auxiliary connector with spring-loaded connection.
- 6) Dimension to inside surface of the closed cabinet door.
- 7) 3WL circuit breaker in connected position.
- 8) 3WL circuit breaker in test position.
- 9) 3WL circuit breaker in disconnected position.
- 10) Fixing holes, 10 mm in diameter.
- 11) Terminal face.
- 12) Guide frame upper edge – only 1000 V and 1150 V AC version.
- 13) Arc quenching space, 1000 V and 1150 V circuit breaker facing grounded or non-conductive surfaces.

Rated circuit breaker current	a	b	c
A			
Up to 2000	10	15	10
2500	15	15	20
3200/4000	30	30	20

For safety clearances to grounded parts and to live parts see page 38.

For vertical connection and flange connection see following page.

3WL Air Circuit Breakers

3WL Air Circuit Breakers/Non-Automatic Air Circuit Breakers up to 6300 A (AC)

Project planning aids

Size II, up to 4000 A, withdrawable version, 3 and 4-pole

Vertical connection up to 3200 A

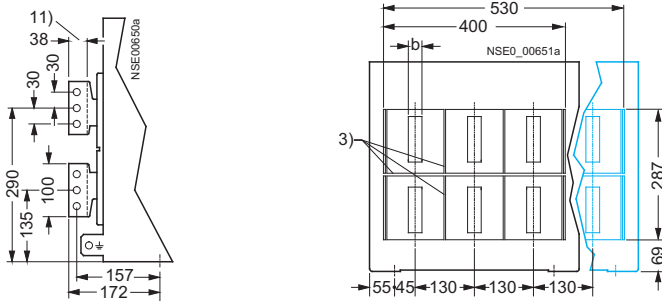

Vertical connection 4000 A

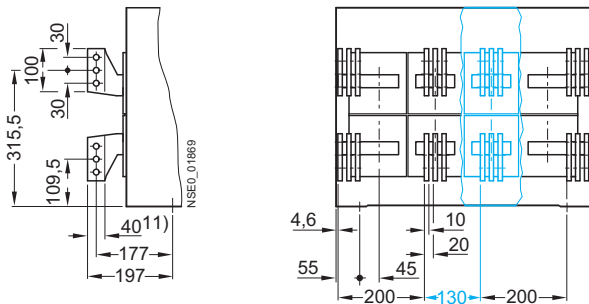

Flange connection

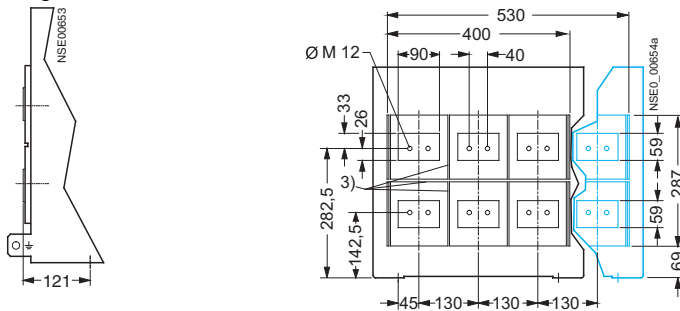

— 4-pole version

3) Rivets (4 mm wide, 5 mm deep) for supporting phase barriers in the system.

11) Terminal face.

For safety clearances to grounded parts and to live parts see page 38.

For more connection options see previous page.

3WL Air Circuit Breakers

3WL Air Circuit Breakers/Non-Automatic Air Circuit Breakers up to 6300 A (AC)

Project planning aids

Size III, up to 6300 A, fixed-mounted version, 3 and 4-pole

Standard version Horizontal connection

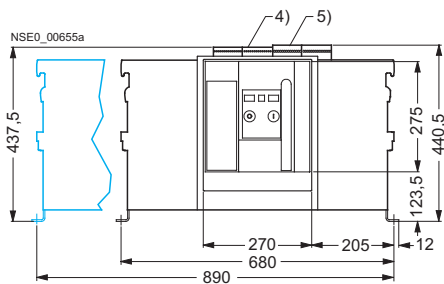

Optional connection variants Front connection (single)

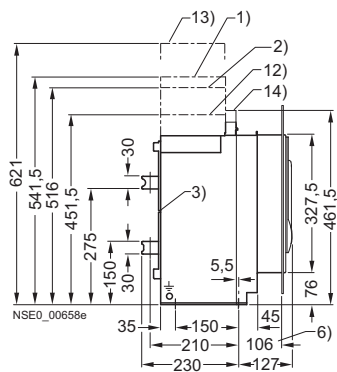
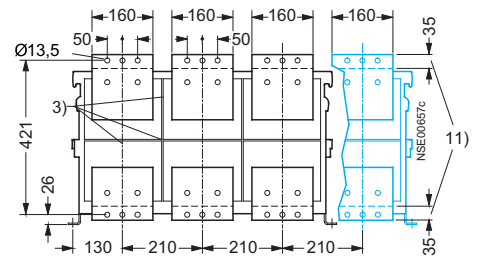
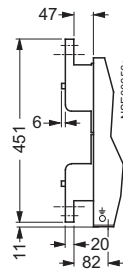

Front connection (double hole) according to DIN 43673

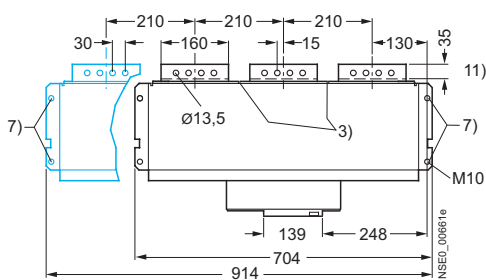
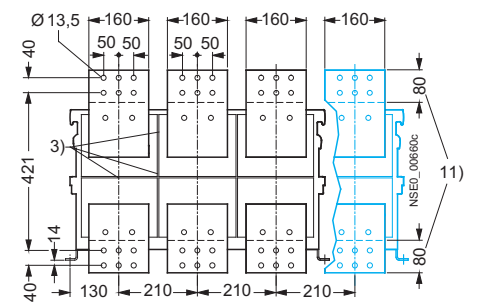
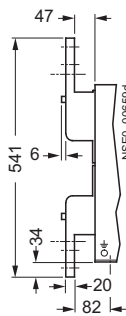

Vertical connection

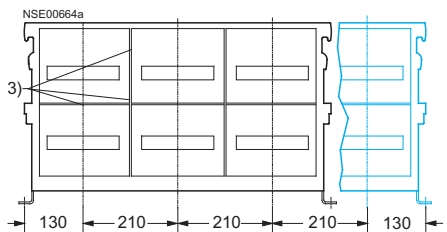
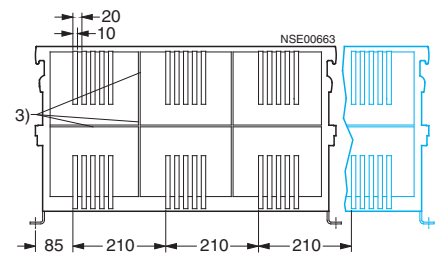
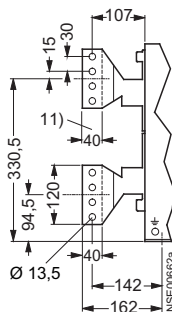

4-pole version

- 1) Mounting space for removal of the arc chutes.
- 2) Arc quenching space "≤ 690 V" – circuit breaker facing grounded or non-conductive surfaces.
- 3) Rivets (4 mm wide, 5 mm deep) for supporting phase barriers in the system.
- 4) Auxiliary connector with SIGUT screw terminals.
- 5) Auxiliary connector with spring-loaded connection.
- 6) Dimension to inside surface of the closed cabinet door.
- 7) Fixing points for mounting the circuit breaker in the system.
- 11) Terminal face.
- 12) Circuit breaker upper edge, only 1000 V circuit breaker and circuit breaker with switching capacity C.

- 13) Arc quenching space, 1000 V circuit breaker and circuit breaker with switching capacity C, facing grounded or non-conductive surfaces.
- 14) Space for electrical auxiliary circuit connections.

For safety clearances to grounded parts and to live parts see page 38.

3WL Air Circuit Breakers

3WL Air Circuit Breakers/Non-Automatic Air Circuit Breakers up to 6300 A (AC)

Project planning aids

Size III, up to 6300 A, withdrawable version, 3 and 4-pole

Standard version
Horizontal connection up to 5000 A

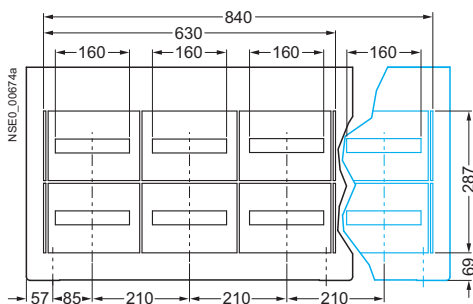
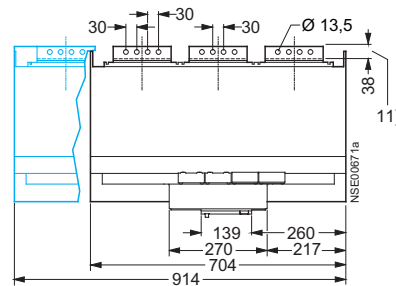
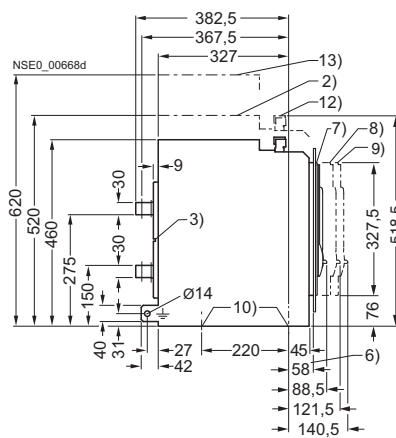
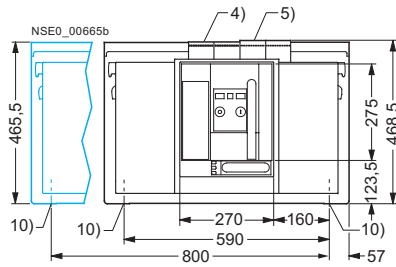

Optional connection variants
Front connection (single hole), up to 4000 A

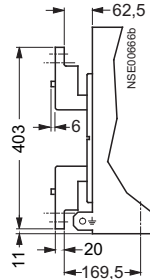

Front connection (double hole) according to DIN 43673, up to 4000 A

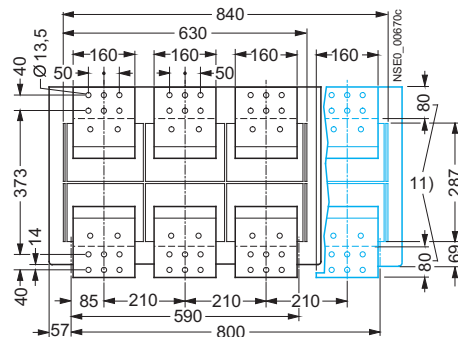
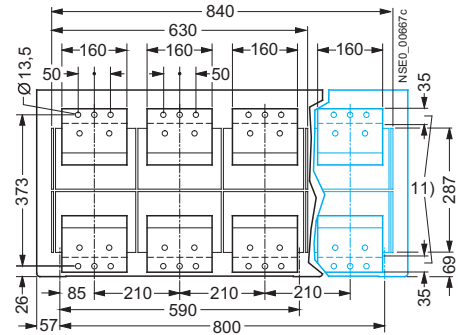
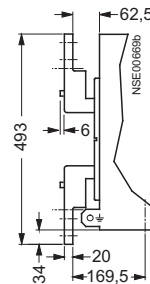

Vertical connection, up to 6300 A

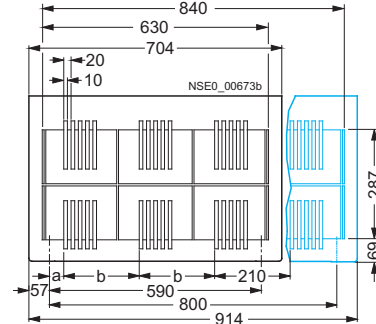
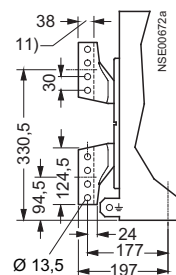

— 4-pole version

- 2) For guide frame ≤ 690 V, without arc chute cover, arc quenching space facing grounded or non-conductive surfaces.
- 3) Rivets (4 mm wide, 5 mm deep) for supporting phase barriers in the system.
- 4) Auxiliary connector with SIGUT screw terminals.
- 5) Auxiliary connector with spring-loaded connection.
- 6) Dimension to inside surface of the closed cabinet door.
- 7) 3WL circuit breaker in connected position.
- 8) 3WL circuit breaker in test position.
- 9) 3WL circuit breaker in disconnected position.
- 10) Fixing holes, 10 mm in diameter.
- 11) Terminal face.
- 12) Guide frame upper edge – only 1000 V and 150/130 kA guide frame.
- 13) Arc quenching space, 1000 V circuit breaker and circuit breaker with switching capacity C, facing grounded or non-conductive surfaces.

For safety clearances to grounded parts and to live parts see page 38.

Flange connections (see following page)

Rated circuit breaker current A	a	b
4000	40	210
5000	40	210
6300	5	245

3WL Air Circuit Breakers

3WL Air Circuit Breakers/Non-Automatic Air Circuit Breakers up to 6300 A (AC)

Project planning aids

Size III, up to 6300 A, withdrawable version, 3 and 4-pole

Flange connection, up to 4000 A

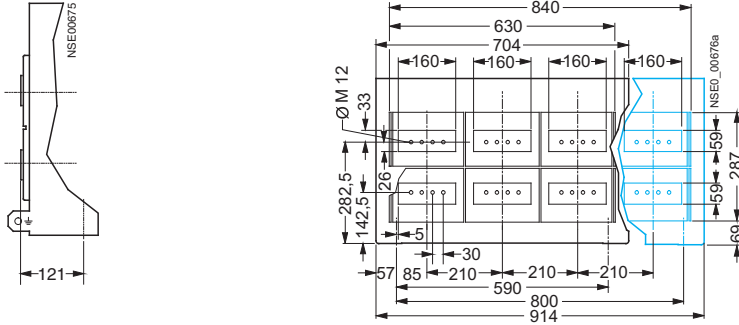

For safety clearances to grounded parts and to live parts see page 38.

For more connection options see previous page.

3WL Air Circuit Breakers/Non-Automatic Air Circuit Breakers up to 6300 A (AC)

Project planning aids

Circuit diagrams

Terminal assignment diagram

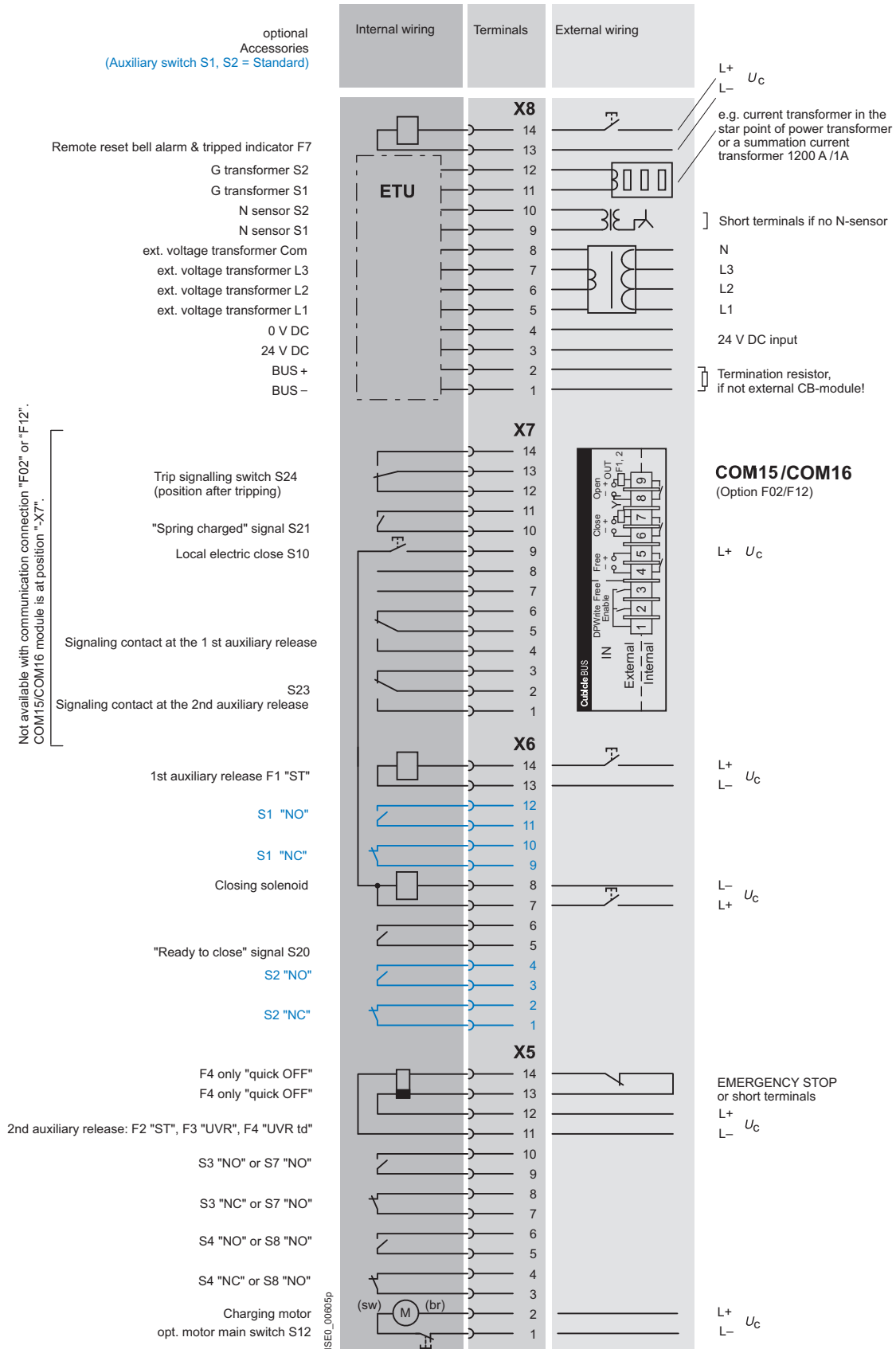

3WL Air Circuit Breakers

3WL Air Circuit Breakers/Non-Automatic Air Circuit Breakers up to 6300 A (AC)

Project planning aids

Example of an overall circuit diagram for 3WL circuit breaker

(3WL1...-4GN4-Z C11 + C22 + K07)

Manual/motorized operating mechanism with stored-energy feature with electrical ON button (option C11), with ready-to-close

signaling switch (option C22), with LSING release, with "UVR" undervoltage release (F3), with "ST" shunt release (F1), with tripped signaling switch (option K07), with auxiliary switch 4 NO + 4 NC.

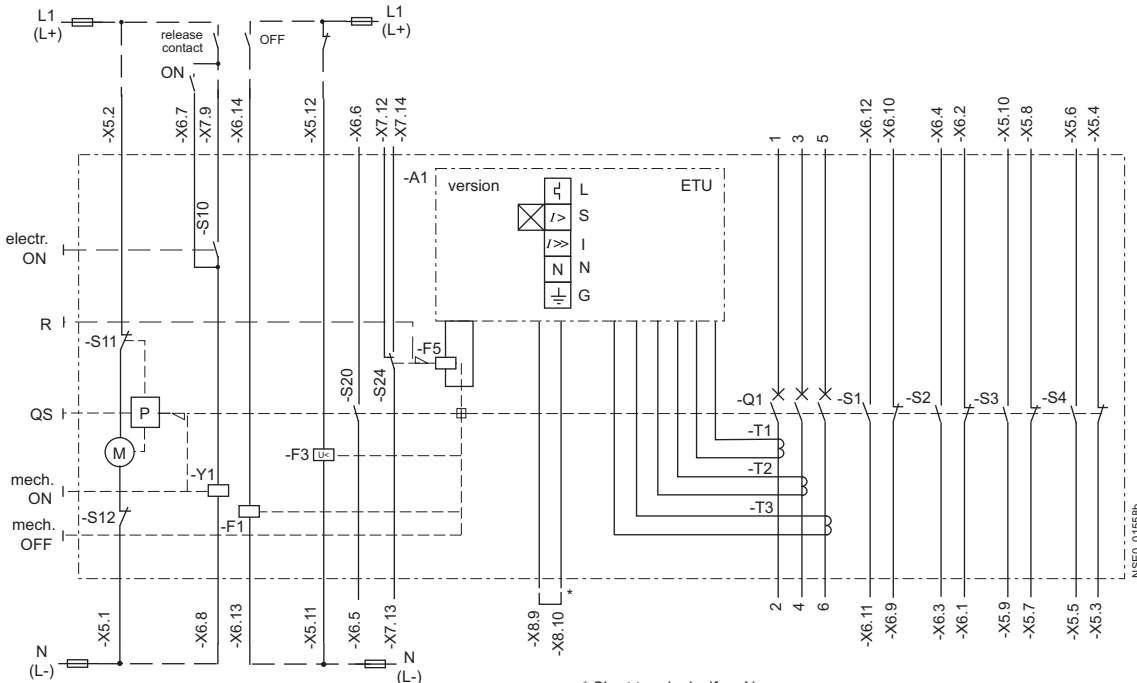

* Short terminals, if no N sensor

Function diagram of 3WL circuit breaker

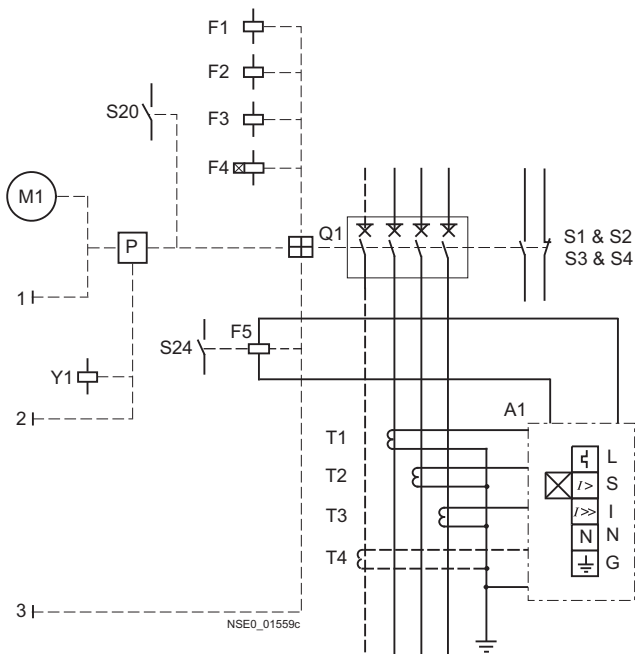

- A1 ETU release
- S1/-S2 1st auxiliary switch block (2 NO + 2 NC)
- S3/-S4 2nd auxiliary switch block (2 NO + 2 NC)
- S7 (optional) 2nd auxiliary switch block, S7 (2 NO) can be used if there is no S3 - S3 and S7 have the same terminal assignment/mounting space
- S8 (optional) 2nd auxiliary switch block, S8 (2 NO) can be used if there is no S4 - S4 and S8 have the same terminal assignment/mounting space
- 3WL1...-2 (2 NO + 2 NC) S1+S2
- 3WL1...-4 (4 NO + 4 NC) S1+S2+S3+S4
- 3WL1...-7 (6 NO + 2 NC) S1+S2+S7+S8
- 3WL1...-8 (5 NO + 3 NC) S1+S2+S3+S8
- S10 Electrical ON button
- S11 Internal motor shutdown switch (if spring is tensioned)
- S12 Motor shutdown switch (no automatic tensioning of spring)
- S20 Ready-to-close signaling switch
- S24 Tripped signaling switch
- F1 1st auxiliary release shunt release
- F3 2nd auxiliary release undervoltage release
- F5 Tripping solenoid
- M Motor for "charging store"
- P Stored-energy mechanism
- QS Actuator lever for "stored-energy feature"
- Q1 Main contacts
- T1/-T2/-T3 Current transformers
- X5/-X6/-X7/-X8 Terminals
- Y1 Closing solenoid
- R Indicator and reset button for release
- X8.9/-X8.10 Connection option: external neutral conductor transformer

3WL Air Circuit Breakers

3WL Air Circuit Breakers/Non-Automatic Air Circuit Breakers up to 6300 A (AC)

Project planning aids

Example of the mode of operation of Zone Selective Interlocking functionality in power distribution

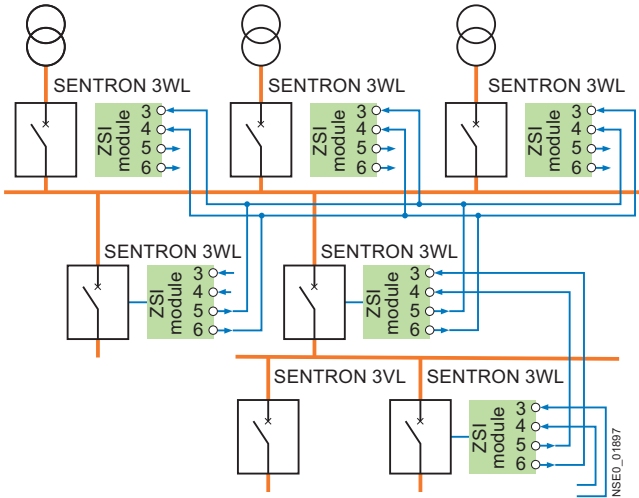

3VL and 3WL circuit breakers used in various staggered levels

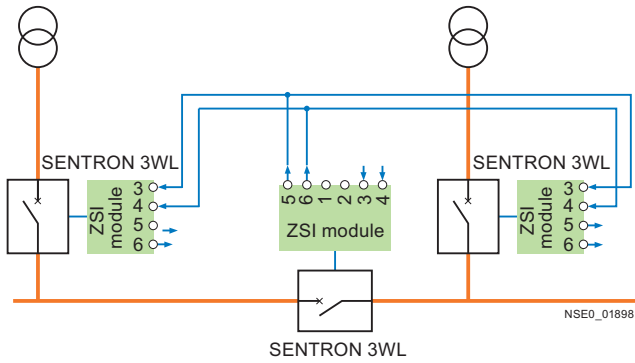

Circuit diagram for a Zone Selective Interlocking functionality with multiple infeed and several outgoing units with 3WL circuit breakers

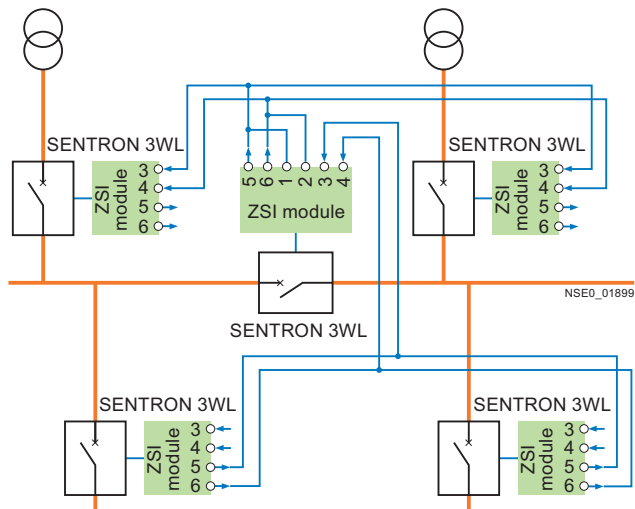

Zone Selective Interlocking functionality: Connection using a coupling switch, use of 3WL circuit breakers

More information

Up-to-date information on the Internet at:

www.siemens.com/sentron

3WL Air Circuit Breakers

3WL Non-Automatic Air Circuit Breakers up to 4000 A (DC)

General data

Technical specifications

Sizes		II		
Type		3WL12 10	3WL12 20	3WL12 40
Rated current I_n at 40 °C Main conductors		A ... 1000	2000	4000
Rated operational voltage U_e (1000 V version, see Catalog LV 10.1, order code *A05*)		V DC ... 600/1000	... 600/1000	... 600/1000
Rated insulation voltage U_i		V DC 1000	1000	1000
Rated impulse withstand voltage U_{imp}				
• Main current paths		kV 12	12	12
• Auxiliary circuits		kV 4	4	4
• Control circuits		kV 2,5	2,5	2,5
Isolating function to EN 60947-2		Yes	Yes	Yes
Permissible ambient temperature				
• Operation		°C -25/+70	-25/+70	-25/+70
• Storage		°C -40/+70	-40/+70	-40/+70
Permissible load				
up to 40 °C	A 1000	2000	4000	
at rear horizontal main circuit connections	A 1000	2000	3640	
up to 55 °C	A 1000	2000	3500	
up to 60 °C	A 1000	2000	3500	
(Cu painted black) up to 70 °C	A 1000	1950	3250	
Power loss at I_n for symmetrical loads Withdrawable circuit breakers		W 280	770	1640
Switching times				
• Make-time		ms 35	35	35
• Opening time		ms 34	34	34
• Electrical make-time (through activation solenoid) ¹⁾		ms 100	100	100
• Electrical opening time (through shunt release)		ms 73	73	73
• Electrical opening time (instantaneous undervoltage release)		ms 73	73	73
Endurance³⁾				
• Mechanical (without maintenance)		Operating cycles 10000	10000	10000
• Mechanical (with maintenance) ²⁾		Operating cycles 15000	15000	15000
• Electrical (without maintenance)		Operating cycles 6000	6000	4000
• 1000 V version		Operating cycles 1000	1000	1000
• Electrical (with maintenance) ²⁾		Operating cycles 15000	15000	15000
Switching frequency				
• 600 V version		1/h 60	60	60
• 1000 V version		1/h 20	20	20
Mounting position				
Degree of protection		IP20 without cabinet door, IP41 with door sealing frame, IP55 with cover		
Auxiliary conductors (Cu)		Standard connection = strain-relief clamp		
Max. number of auxiliary conductors × cross-section (solid/stranded)		<ul style="list-style-type: none"> • Without end sleeve • With end sleeve acc. to DIN 46228 Part 2 • With twin end sleeve 		
		2 × 0.5 mm ² (AWG 20) ... 2 × 1.5 mm ² (AWG 16); 1 × 2.5 mm ² (AWG 14) 1 × 0.5 mm ² (AWG 20) ... 1 × 1.5 mm ² (AWG 16) 2 × 0.5 mm ² (AWG 20) ... 2 × 1.5 mm ² (AWG 16)		
		Optional connection = tension spring		
		<ul style="list-style-type: none"> • Without end sleeve • With end sleeve acc. to DIN 46228 Part 2 		
		2 × 0.5 mm ² (AWG 20) ... 2 × 2.5 mm ² (AWG 14) 2 × 0.5 mm ² (AWG 20) ... 2 × 1.5 mm ² (AWG 16)		
Weights				
3-pole	• Fixed-mounted circuit breakers	kg 56	56	64
	• Withdrawable circuit breakers	kg 60	60	68
	• Guide frames	kg 31	31	45
4-pole	• Fixed-mounted circuit breakers	kg 67	67	77
	• Withdrawable circuit breakers	kg 72	72	82
	• Guide frames	kg 37	37	54

¹⁾ Make-time through activation solenoid for synchronization purposes (short-time excited) 50 ms.

²⁾ Maintenance means: replace main contact elements and arc chutes (see Operating Manual).

³⁾ Further technical specifications on request.

Sizes		II	
Type		3WL12	
Switching capacity class		DC	
Short-circuit breaking capacity			
Up to 220 V DC	I_{cc}	kA 35	
Up to 300 V DC	I_{cc}	kA 30	
Up to 600 V DC	I_{cc}	kA 25	
Up to 1000 V DC	I_{cc}	kA 20	
Rated short-time withstand current I_{cw}			
0.5 s		kA --	
1 s		kA 35 ¹⁾ /30 ²⁾ /25 ³⁾ /20 ⁴⁾	
2 s		kA --	
3 s		kA --	

¹⁾ At $U_e = 220$ V DC.

²⁾ At $U_e = 300$ V DC.

³⁾ At $U_e = 600$ V DC.

⁴⁾ At $U_e = 1000$ V DC.

3WL Air Circuit Breakers

3WL Non-Automatic Air Circuit Breakers up to 4000 A (DC)

Project planning aids

Characteristic curves

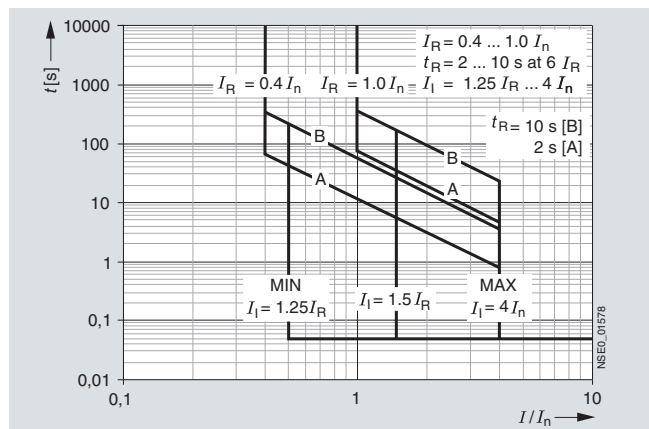

DIGmat S100 characteristic curve

Dimensional drawings

DIGmat S100

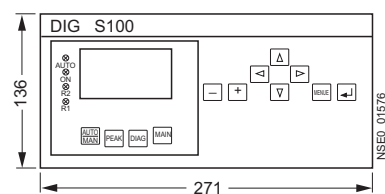

DIGmat S100

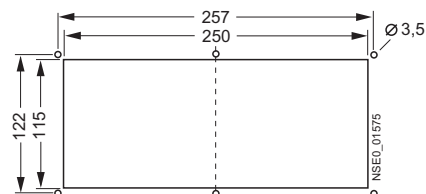

DIGmat S100 drilling pattern

3WL Air Circuit Breakers

3WL Non-Automatic Air Circuit Breakers up to 4000 A (DC)

Project planning aids

Size II, up to 4000 A, fixed-mounted version, 3 and 4-pole

Standard version Horizontal connection

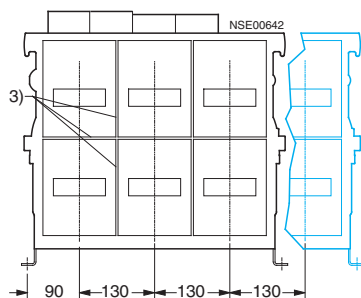
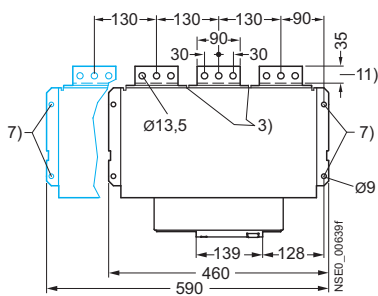
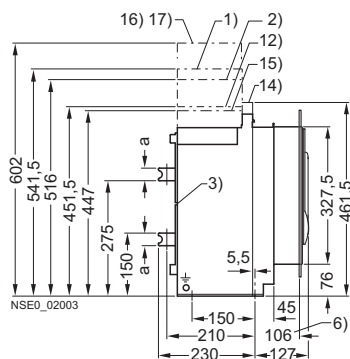
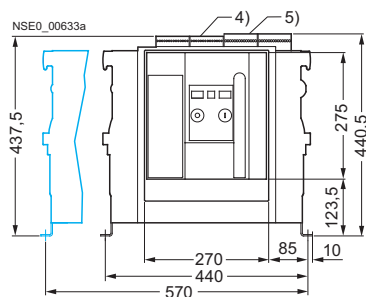

Optional connection variants Front connection (single)

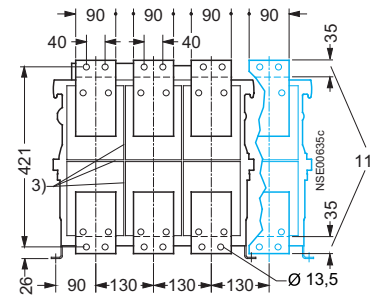
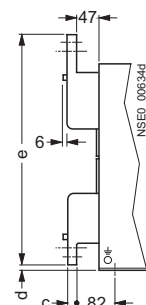

Front connection (double hole) according to DIN 43673

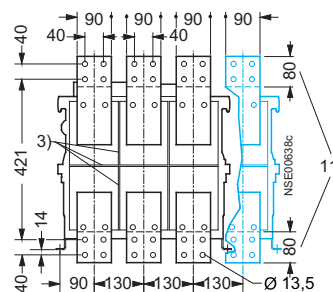
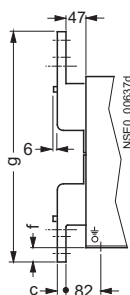

Vertical connection

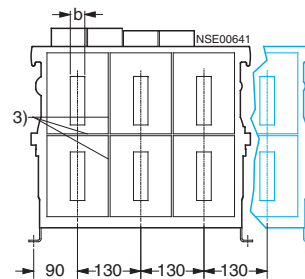
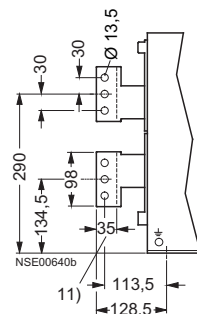

4-pole version

- 1) Mounting space for removal of the arc chutes.
- 2) Arc quenching space "≤ 690 V" – circuit breaker facing grounded or non-conductive surfaces.
- 3) Rivets (4 mm wide, 5 mm deep) for supporting phase barriers in the system.
- 4) Auxiliary connector with SIGUT screw terminals.
- 5) Auxiliary connector with spring-loaded connection.
- 6) Dimension to inside surface of the closed cabinet door.
- 7) Fixing points for mounting the circuit breaker in the system.
- 11) Terminal face.
- 12) Circuit breaker upper edge, only 1000 V circuit breaker.
- 14) Space for electrical auxiliary circuit connections.
- 15) Arc quenching space, 300 V circuit breaker facing grounded or non-conductive surfaces.
- 16) Arc quenching space, 600 V circuit breaker facing grounded or non-conductive surfaces.
- 17) Arc quenching space, 1000 V circuit breaker (with high arc chute) facing grounded or non-conductive surfaces.

Rated circuit breaker current A	a	b	c	d	e	f	g
Up to 2000	10	15	10	11	451	34	541
4000	30	30	20	6	461	39	551

For safety clearances to grounded parts and to live parts see page 38.

3WL Air Circuit Breakers

3WL Non-Automatic Air Circuit Breakers up to 4000 A (DC)

Project planning aids

Size II, up to 4000 A, draw-out technology, 3 and 4-pole

Vertical connection

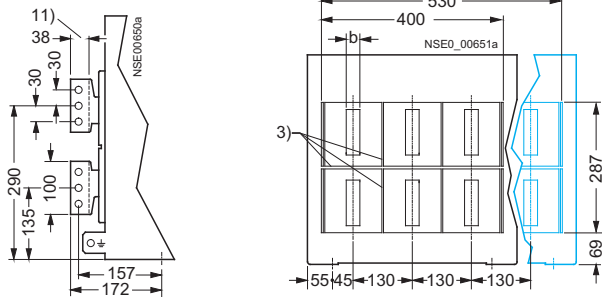

Flange connection

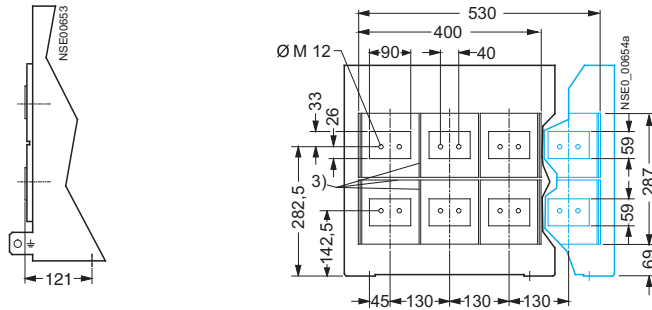

4-pole version

- 3) Rivets (4 mm wide, 5 mm deep) for supporting phase barriers in the system.
11) Terminal face.

For safety clearances to grounded parts and to live parts see page 38.

For more connection options see previous page.

3WL Air Circuit Breakers

3WL Non-Automatic Air Circuit Breakers up to 4000 A (DC)

Project planning aids

Circuit diagrams

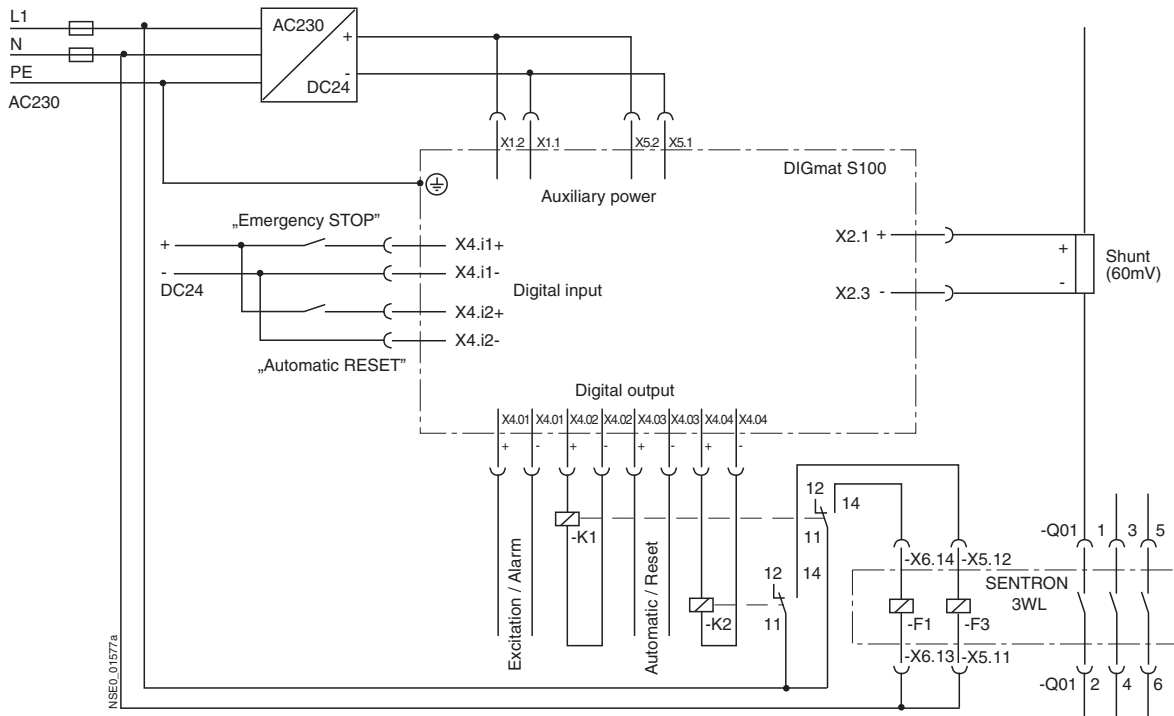

Circuit diagram of the DIGmat S100 and the 3WL non-automatic air circuit breaker

Application examples

Rated operational voltage	Required, series-connected breaks at rated voltage	For 3-pole non-automatic air circuit breakers (operational currents up to 4000 A/conducting path)	For 4-pole non-automatic air circuit breakers (operational currents up to 4000 A/conducting path)
Up to 300 V + 10 %		 1-pole, 2 parallel conducting paths, only with grounded-neutral system	 1-pole, 3 parallel conducting paths, only with grounded-neutral system
Over 300 V + 10 % Up to 600 V + 10 %		 2-pole, only with grounded-neutral system	 1-pole, 2 parallel conducting paths, only with grounded-neutral system
Over 600 V + 10 % Up to 1000 V + 10 % (version for 1000 V required, order with "-Z" and order code A05)		 1-pole, only with grounded-neutral system	 1-pole, only with grounded-neutral system

The connection to the circuit breakers is not dependent on direction and polarity; the circuit diagrams can be adapted accordingly.

If the parallel or series connections are made directly at the connecting bars, for thermal reasons the continuous load on the circuit breakers must only be 80 % of the permissible operational

current. If the parallel or series connection is made at a distance of 1 m from the connecting bars, the circuit breaker can be used at full operational current load.

- Grounded-neutral system
- Load

3WL Air Circuit Breakers

3WL Non-Automatic Air Circuit Breakers up to 4000 A (DC)

Project planning aids

More information

Up-to-date information on the Internet at:

www.siemens.com/sentron

Siemens AG
Infrastructure & Cities Sector
Low and Medium Voltage Division
Low Voltage Distribution
Postfach 10 09 53
93009 REGENSBURG
GERMANY

www.siemens.com/lowvoltage

Subject to change without prior notice
PDF only
MP.R3.LV.0000.00.2.92
PH 1111 58 En
© Siemens AG 2011

The information provided in this Configuration Manual contains descriptions or characteristics of performance which in case of actual use do not always apply as described or which may change as a result of further development of the products. An obligation to provide the respective characteristics shall only exist if expressly agreed in the terms of contract. Availability and technical specifications are subject to change without notice.

All product designations may be trademarks or product names of Siemens AG or supplier companies whose use by third parties for their own purposes could violate the rights of the owners.